

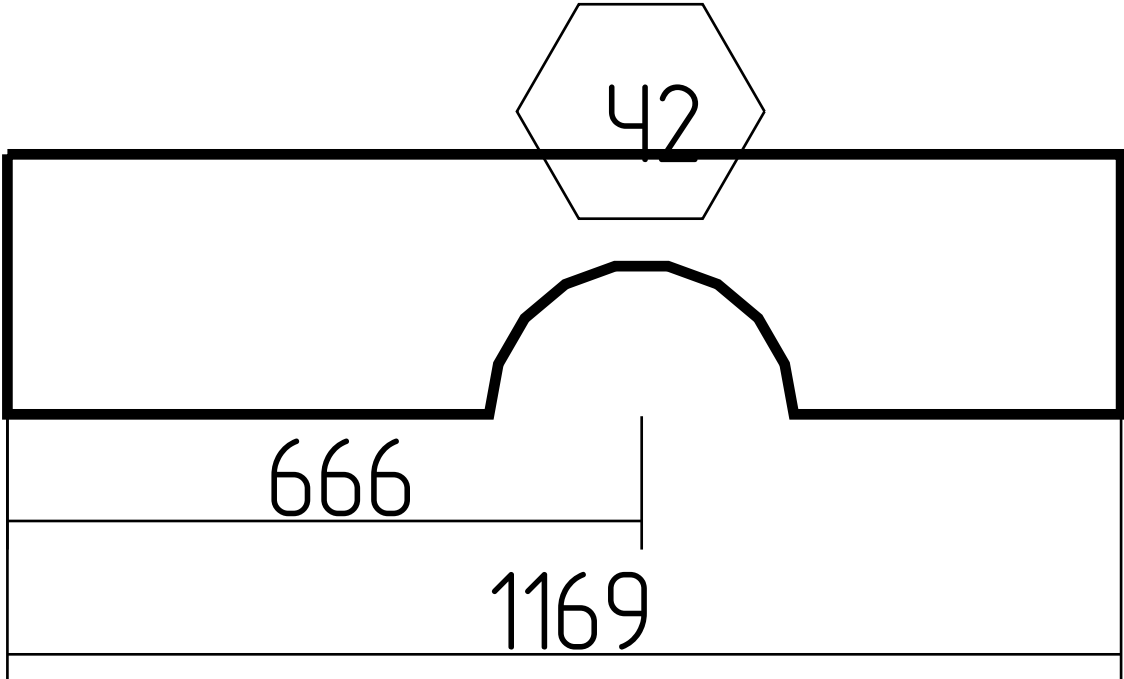
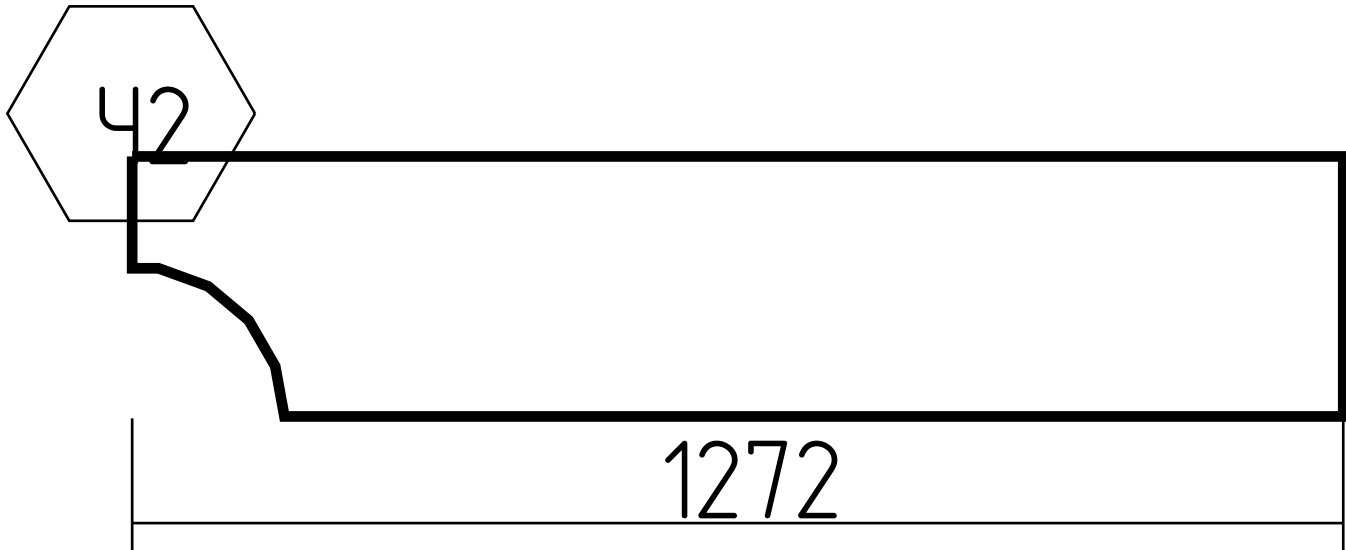
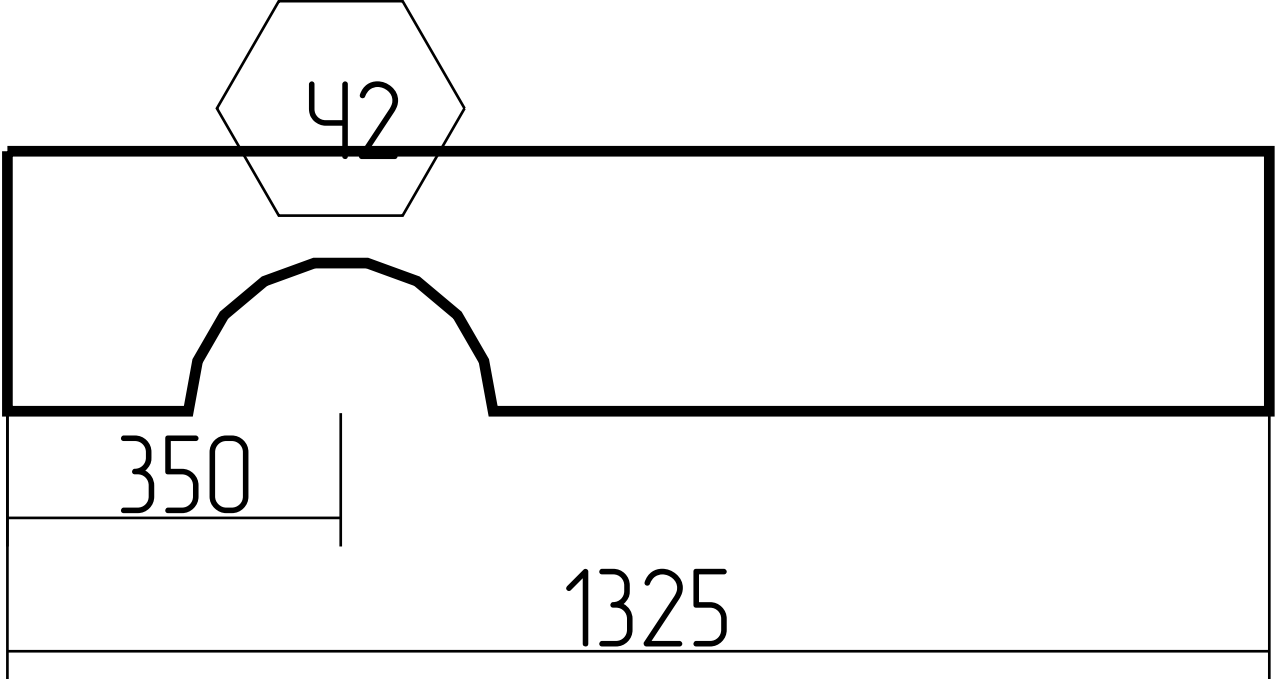
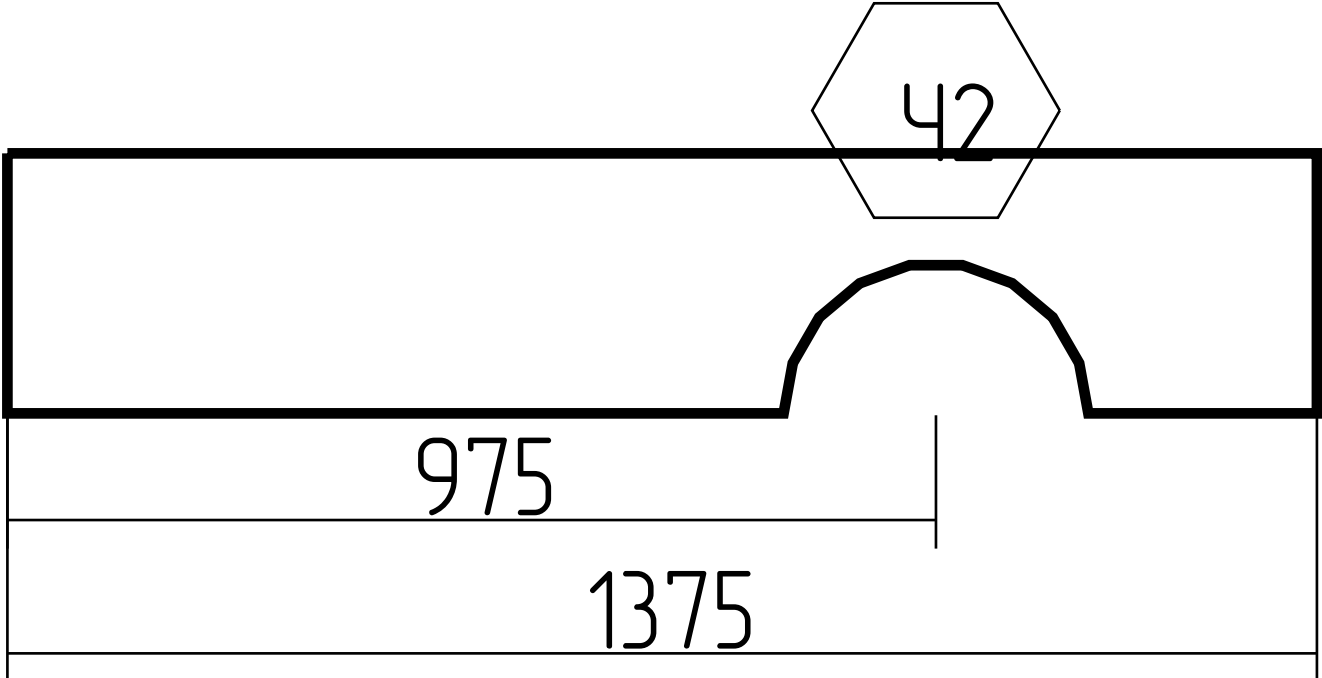
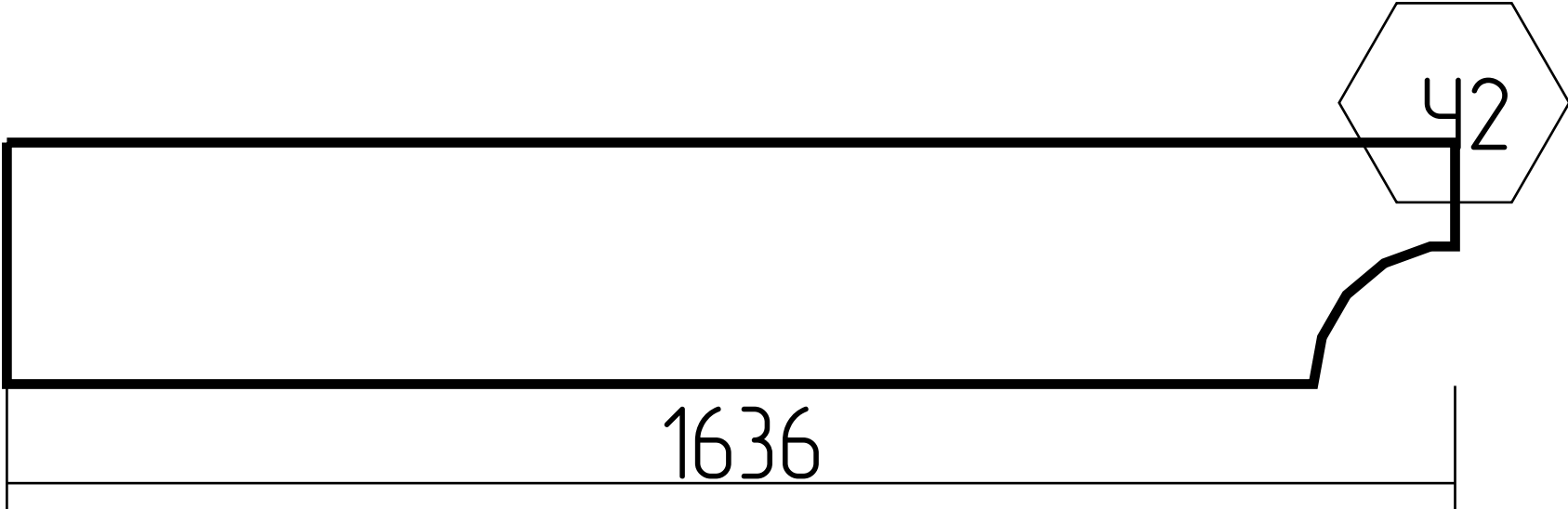

№	Марк.	Эскиз детали	Кол-во (шт)	Объем (м.куд.)
1	1.26-1		1	0.094
2	1.24-2		1	0.102
3	1.6-2, 1.7-2, 1.8-2, 1.9-2, 1.16-2, 1.17-2, 1.18-2, 1.19-2		8	0.853
4	1.6-3, 1.7-3, 1.8-3, 1.9-3, 1.10-3, 1.15-3, 1.16-3, 1.17-3, 1.18-3, 1.19-3		10	1.106
5	1.21-1		1	0.132

Спецификация: ось 1

Лист

1:100

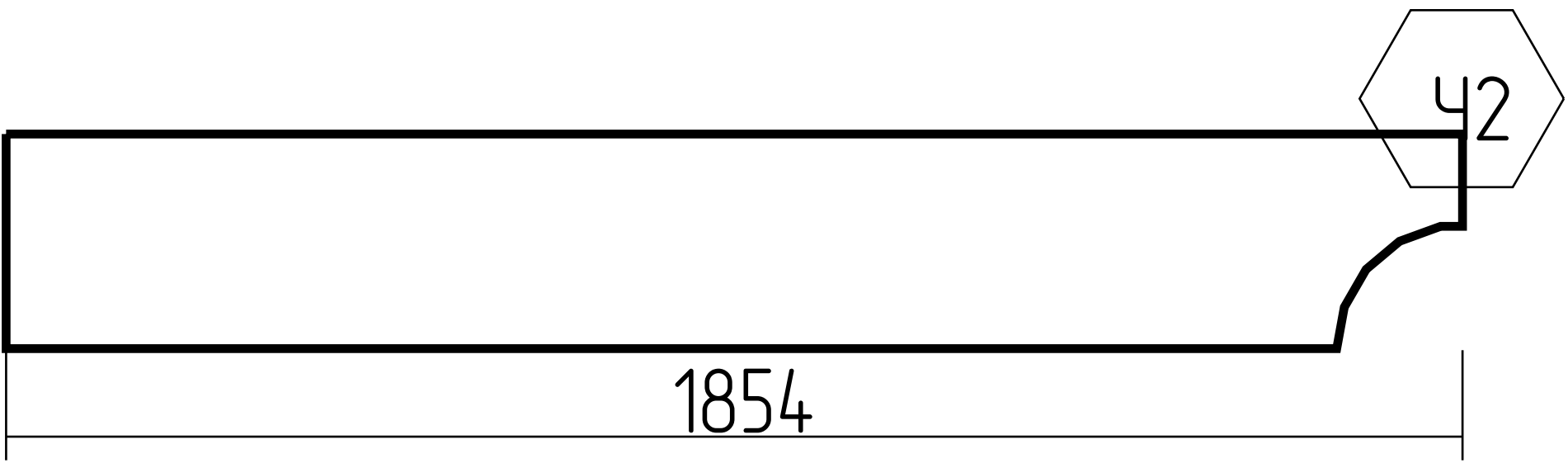
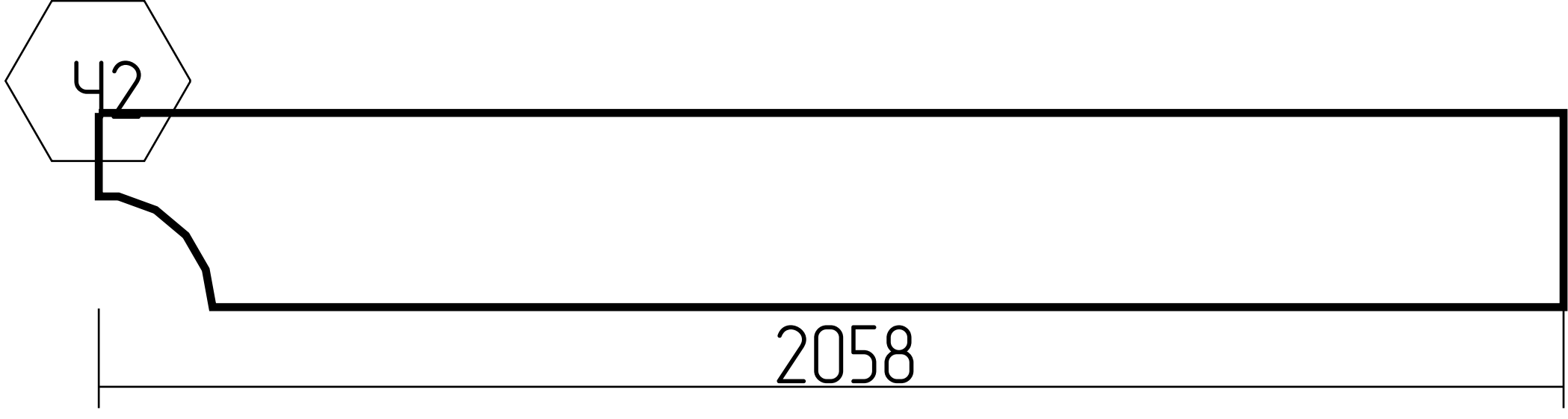
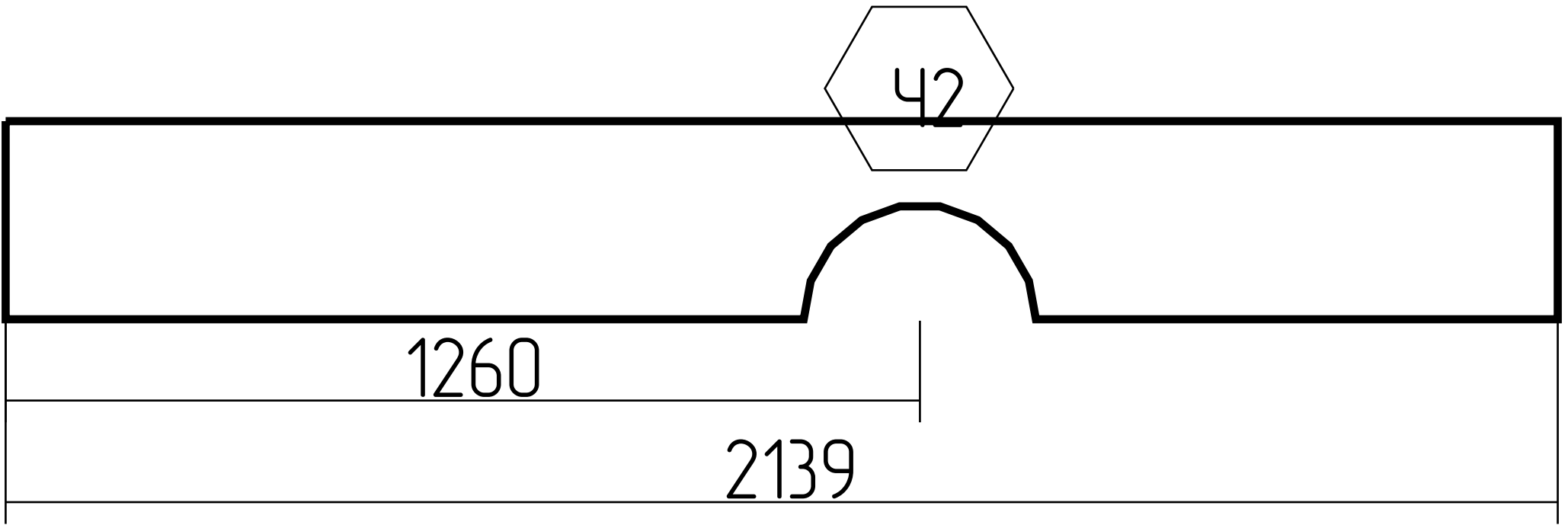
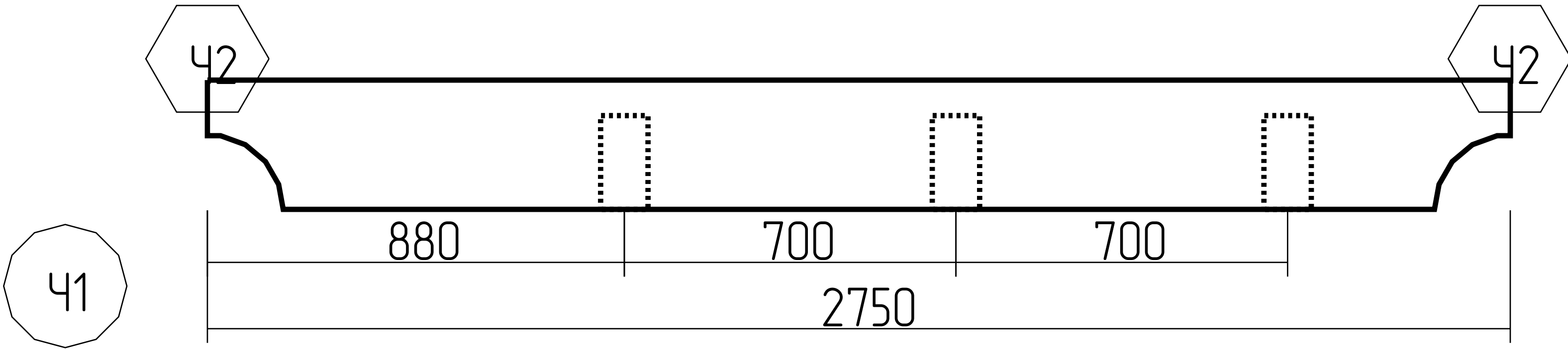
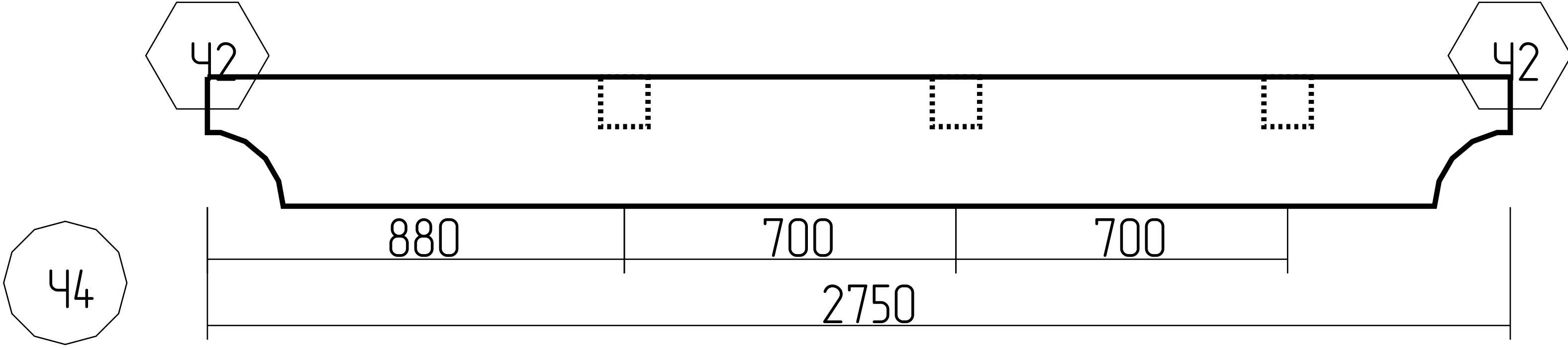
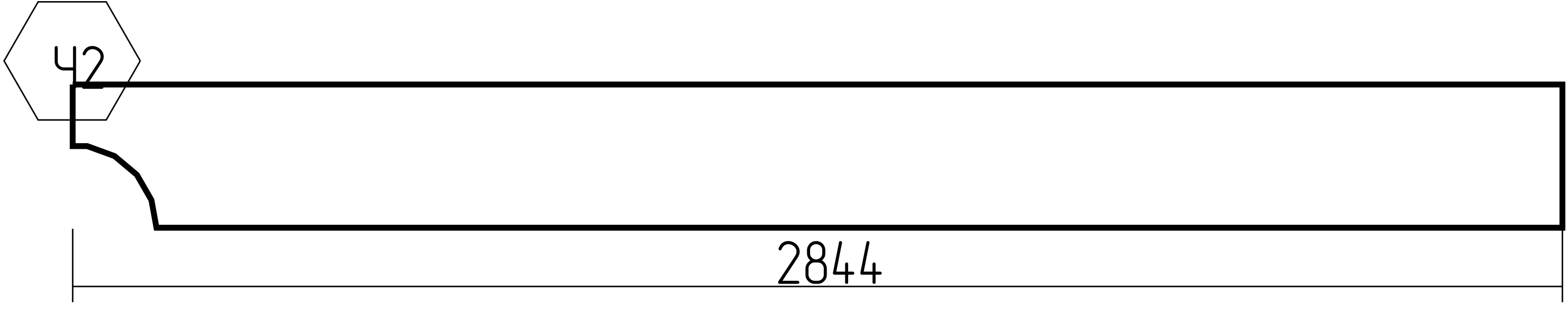
6	1.24-1		1	0.149
7	1.22-2		1	0.166
8	1.25-1		1	0.172
9	1.1-2		1	0.221
10	1.11-2		1	0.221
11	1.20-2		1	0.229

Спецификация: ось 1

Лист

1:100

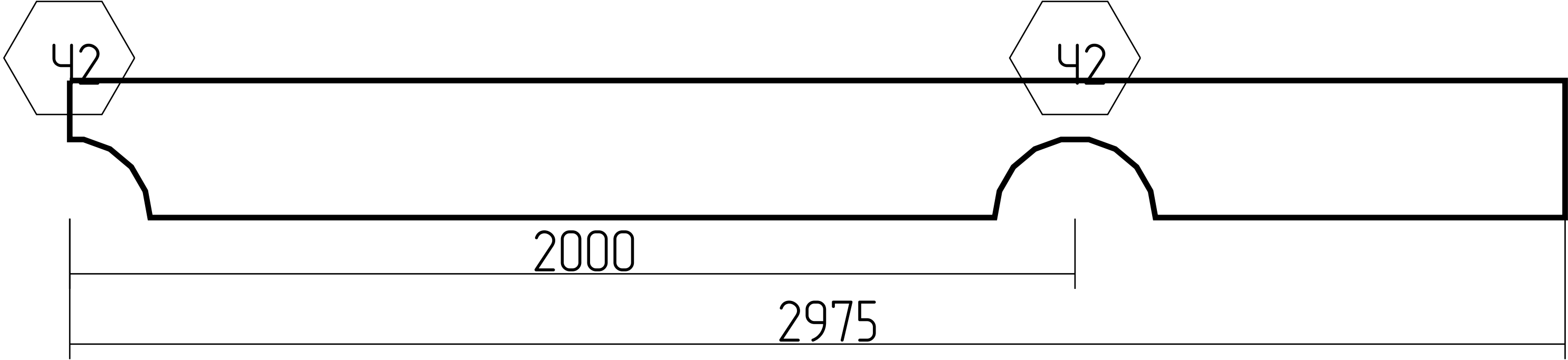
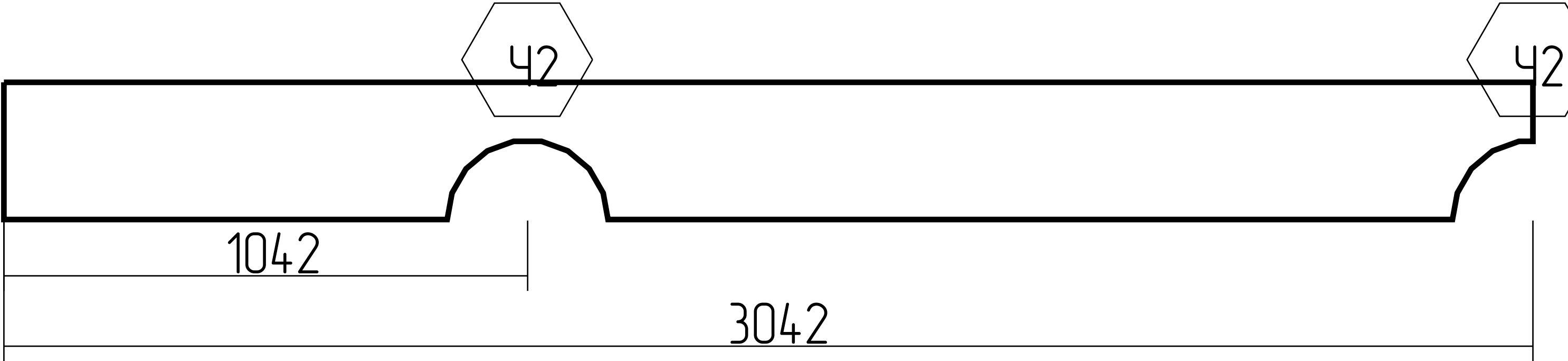
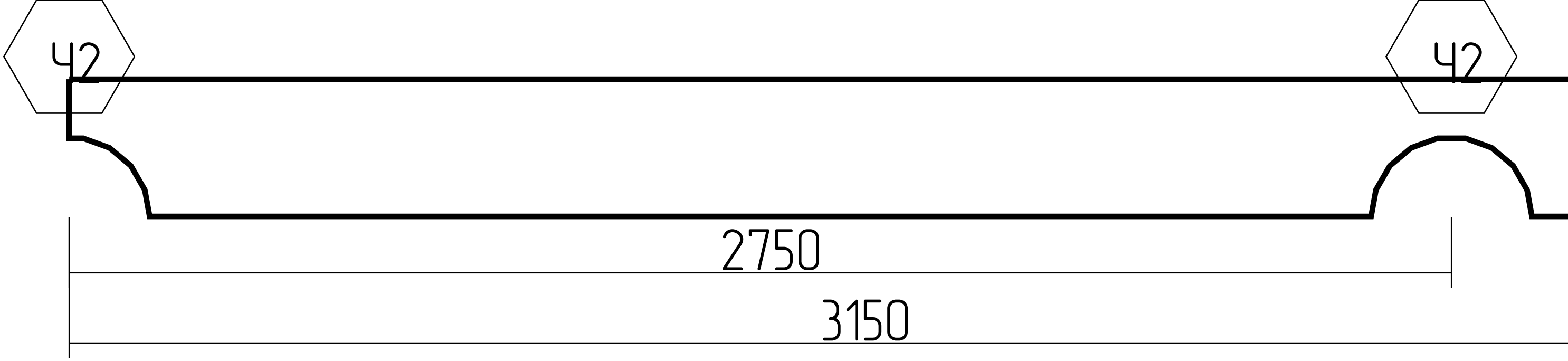
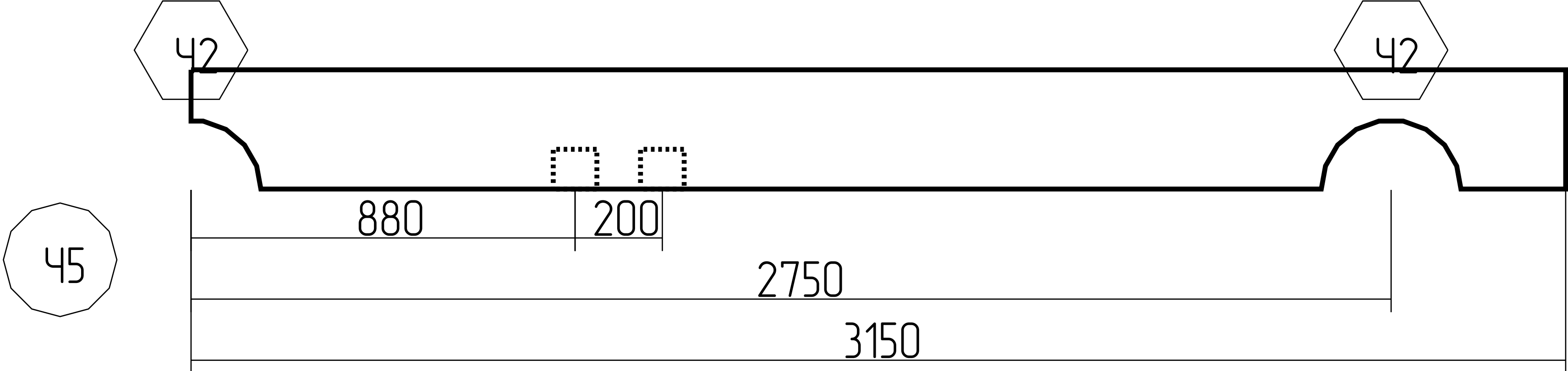
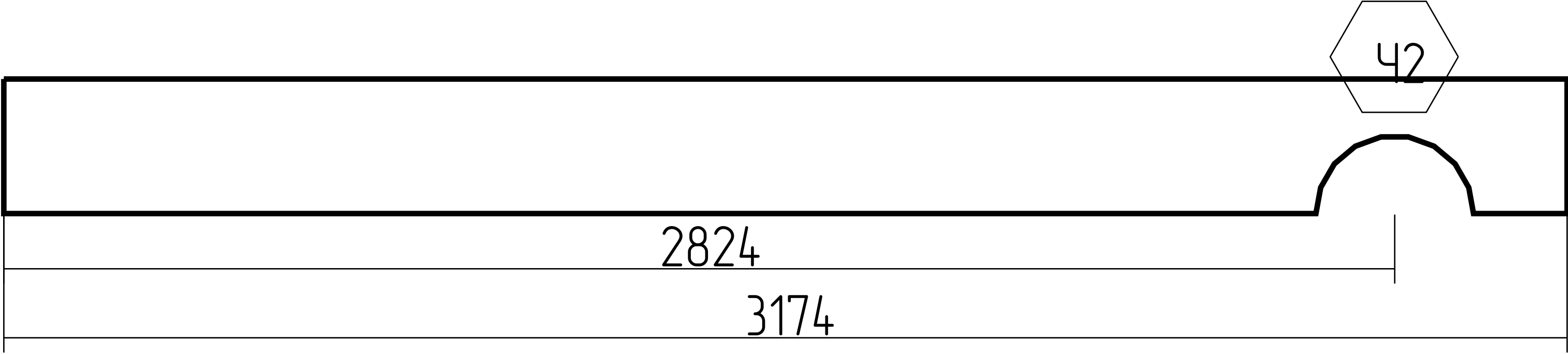
12	1.15-2		1	0.239
13	1.22-1		1	0.245
14	1.2-2, 1.3-1, 1.4-2, 1.5-1, 1.13-1, 1.14-2, 1.15-1,		7	1.773
15	1.12-2		1	0.253
16	1.19-1		1	0.255

Спецификация: ось 1

Лист

1:100

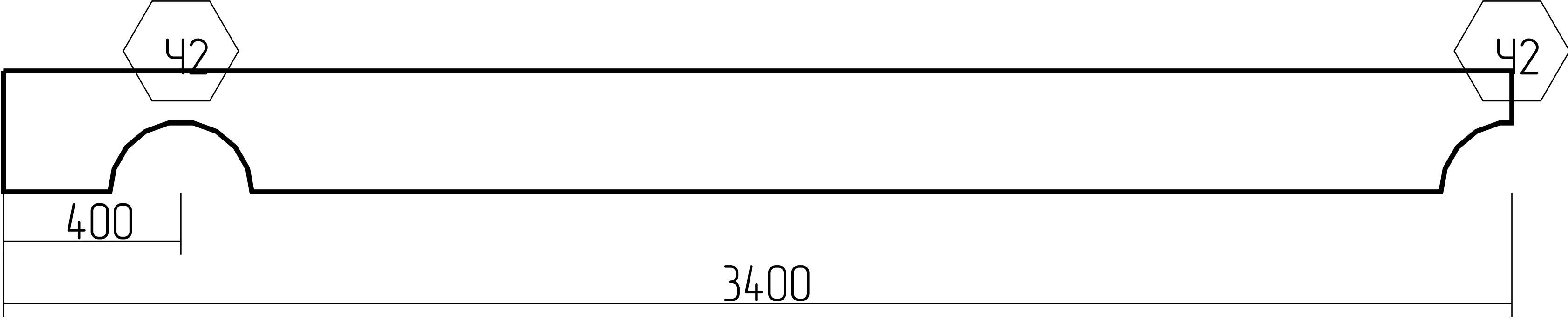
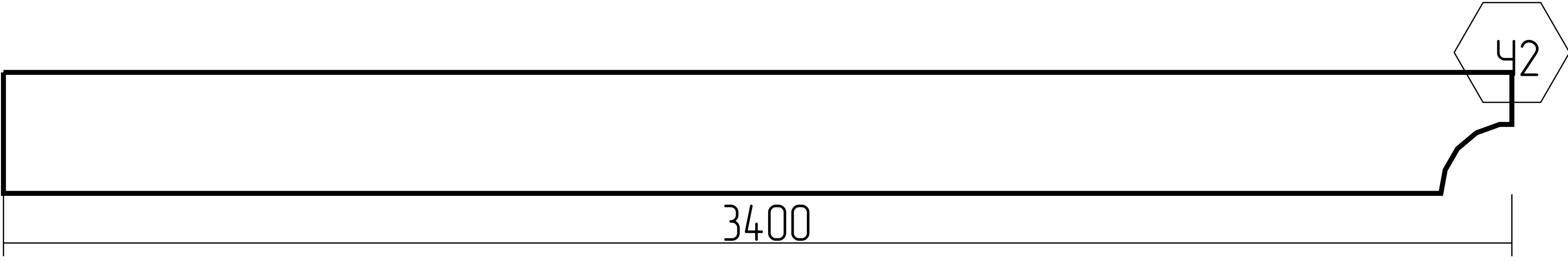
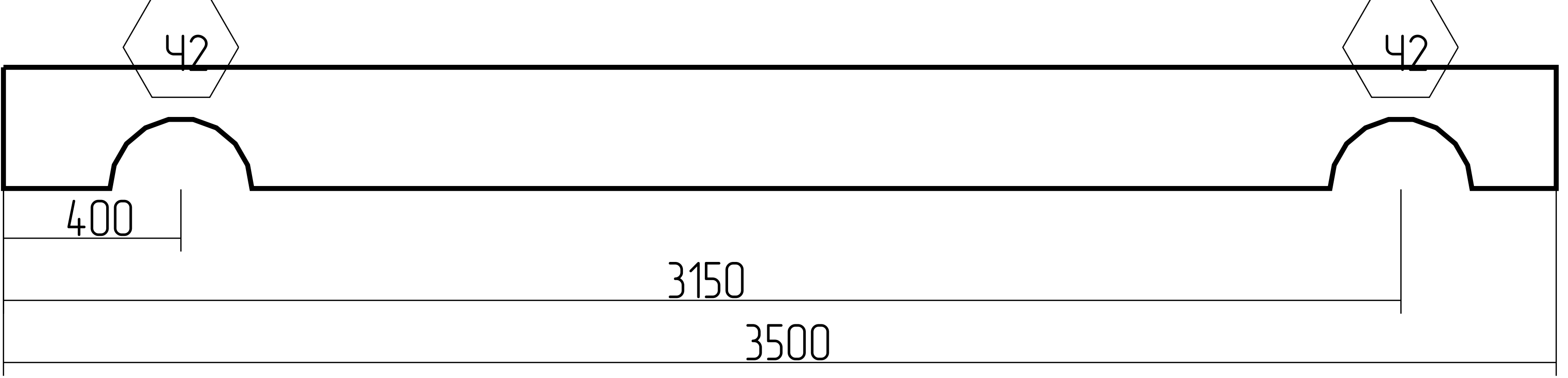
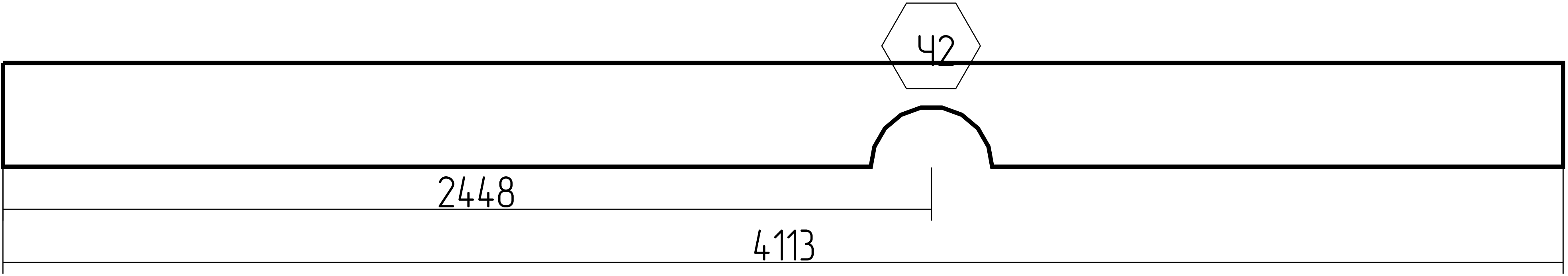
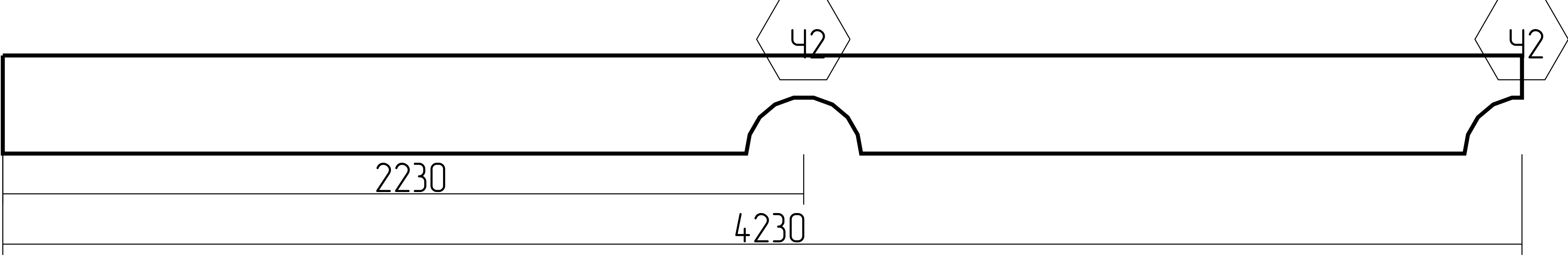
17	1.1-1, 1.11-1		2	0.547
18	1.10-1		1	0.273
19	1.6-1, 1.7-1, 1.8-1, 1.9-1, 1.16-1, 1.17-1, 1.18-1,		7	1.970
20	1.23-1		1	0.331
21	1.20-1		1	0.340

Спецификация: ось 1

Лист  
1:100

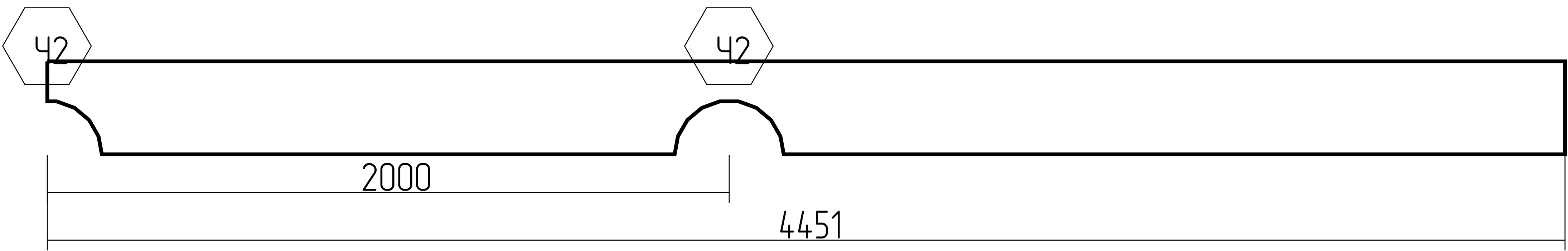
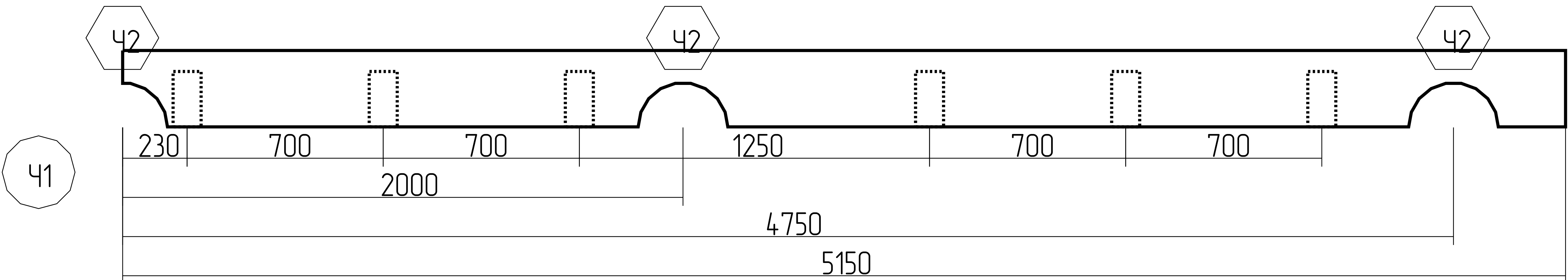
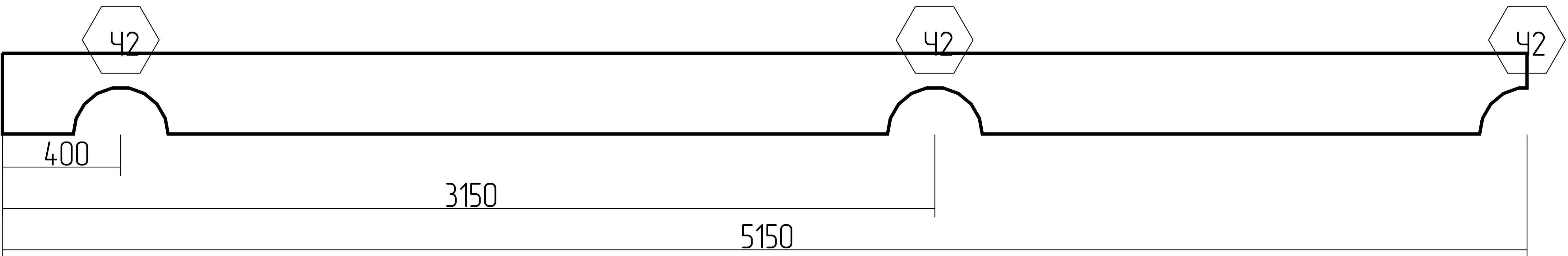
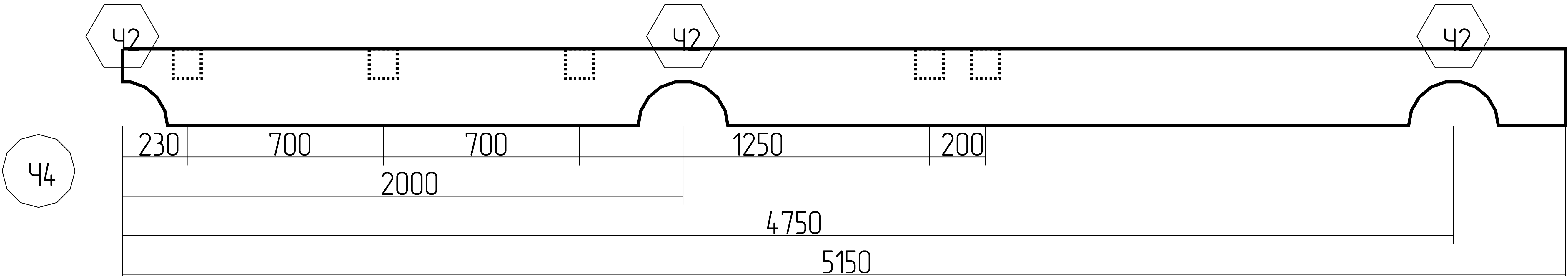
22	1.21-2		1	0.358
23	1.1-3		1	0.414
24	1.2-1, 1.3-2, 1.4-1, 1.5-2, 1.13-2, 1.14-1		6	2.485
25	1.11-3		1	0.414



Спецификация: ось 1

Лист

1:100

26	1.12-1		1	0.414
27	1.10-2		1	0.460
Итого:			61	14.218

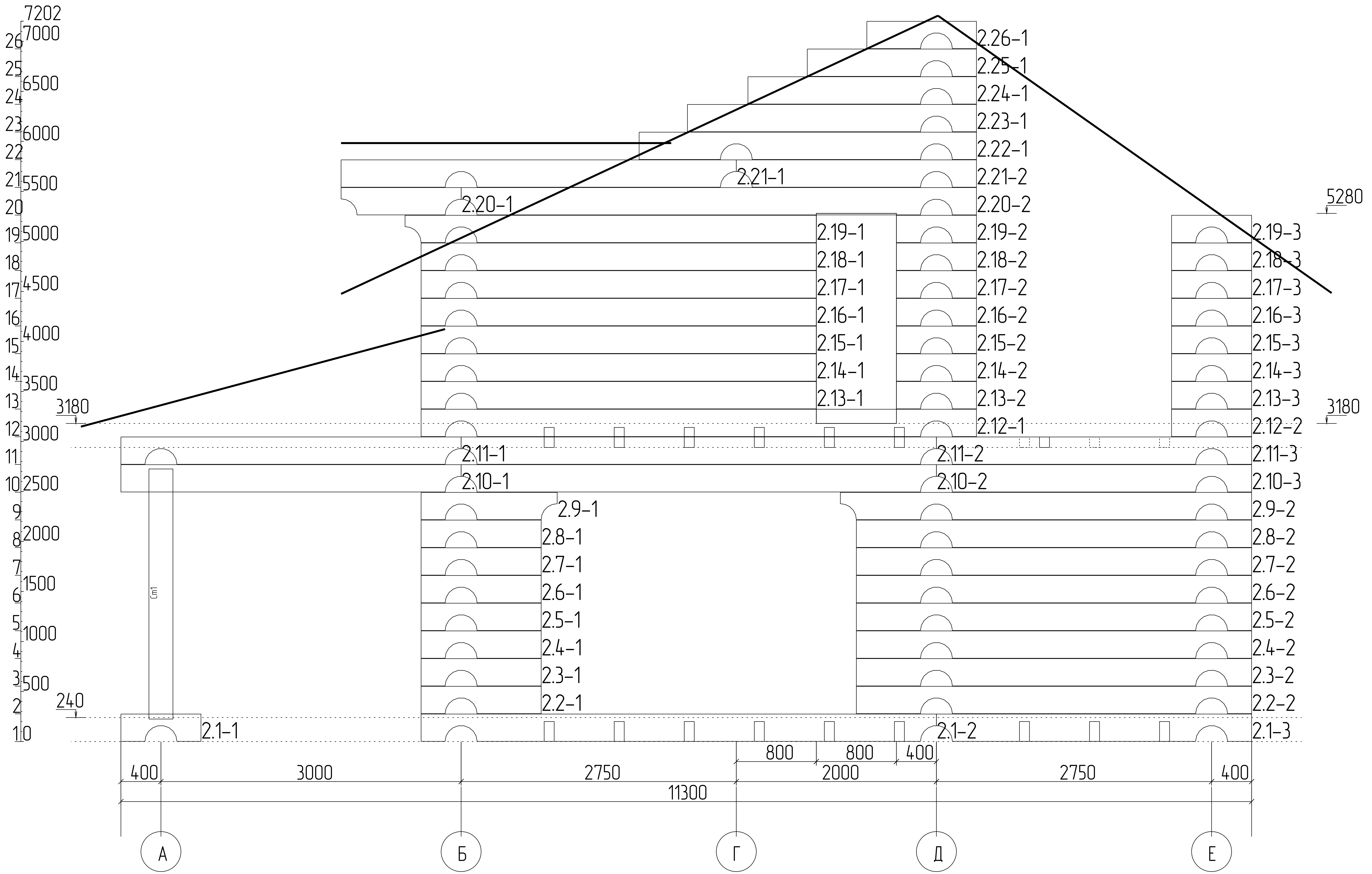
				Спецификация: ось 1	Лист
					1:100



					План порядовки: ось 2	Лист
						1:49

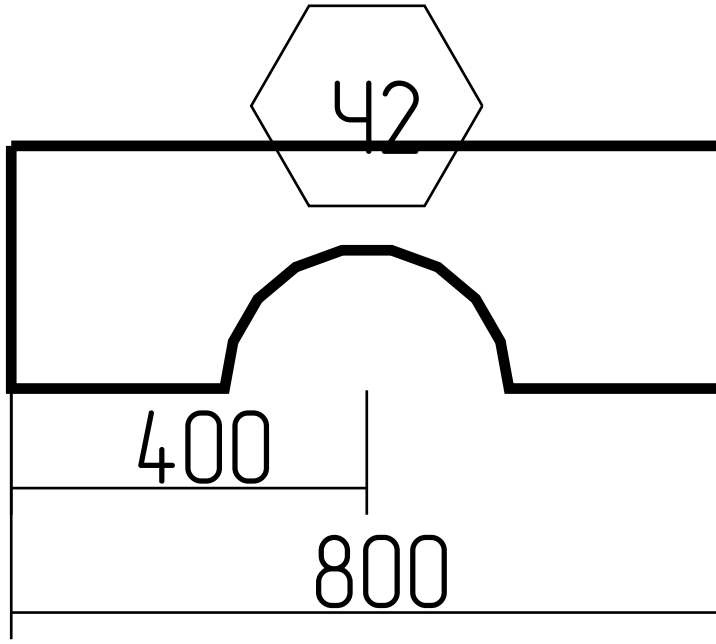
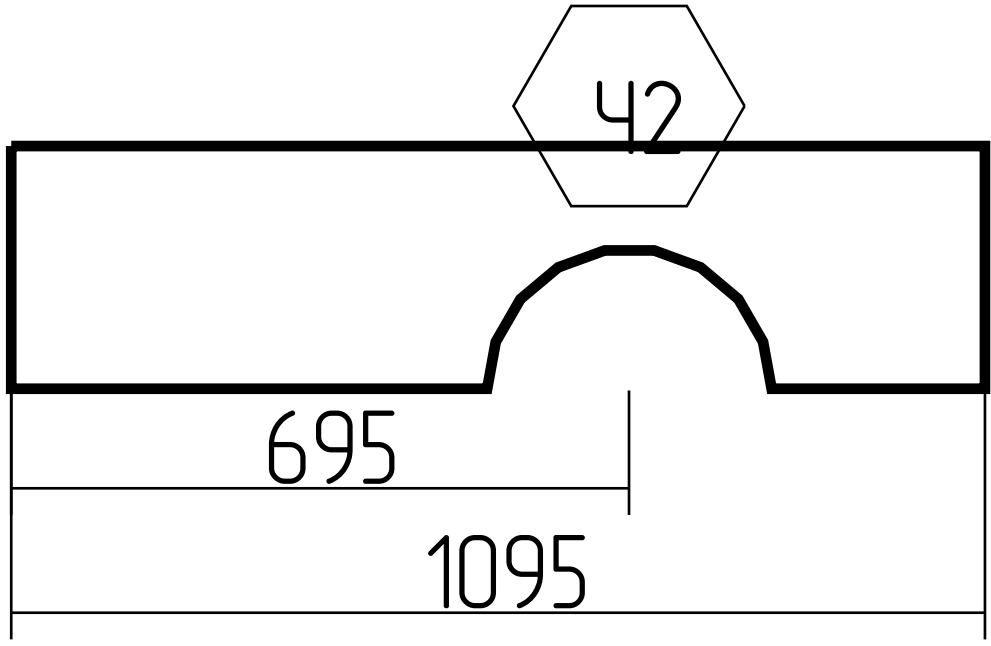
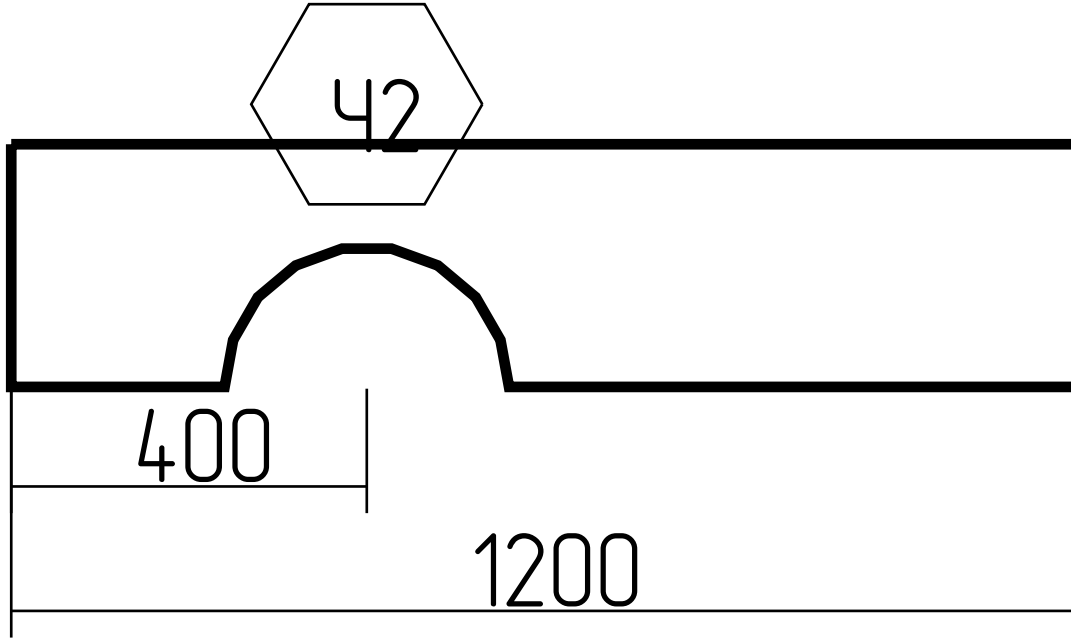
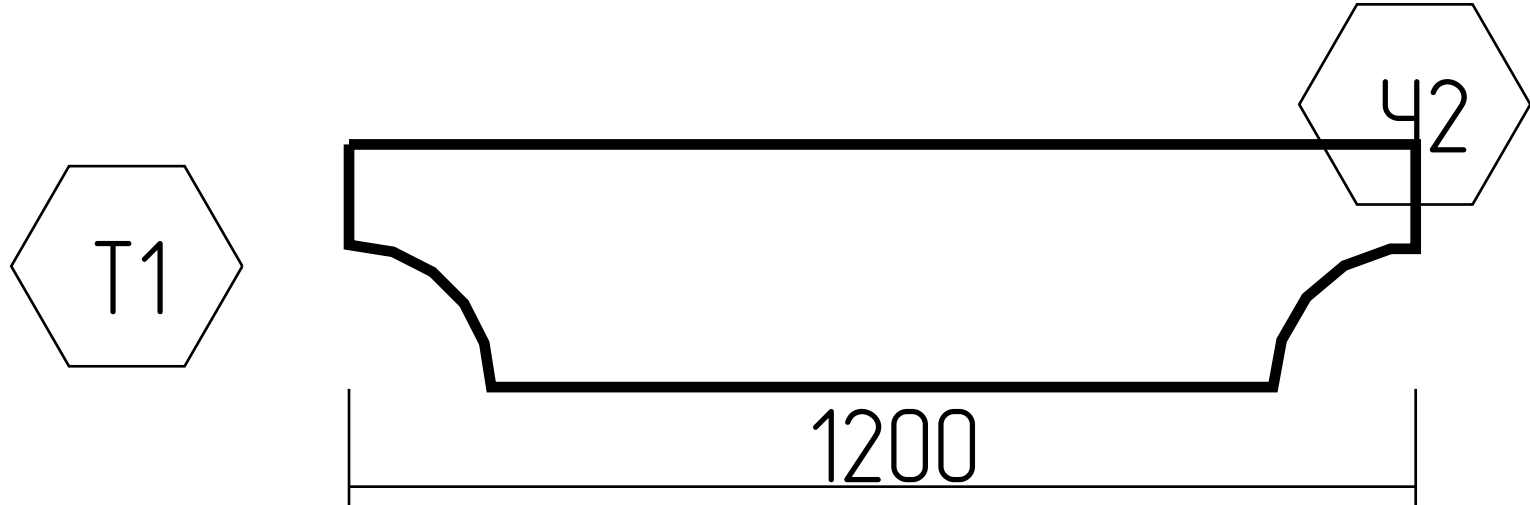
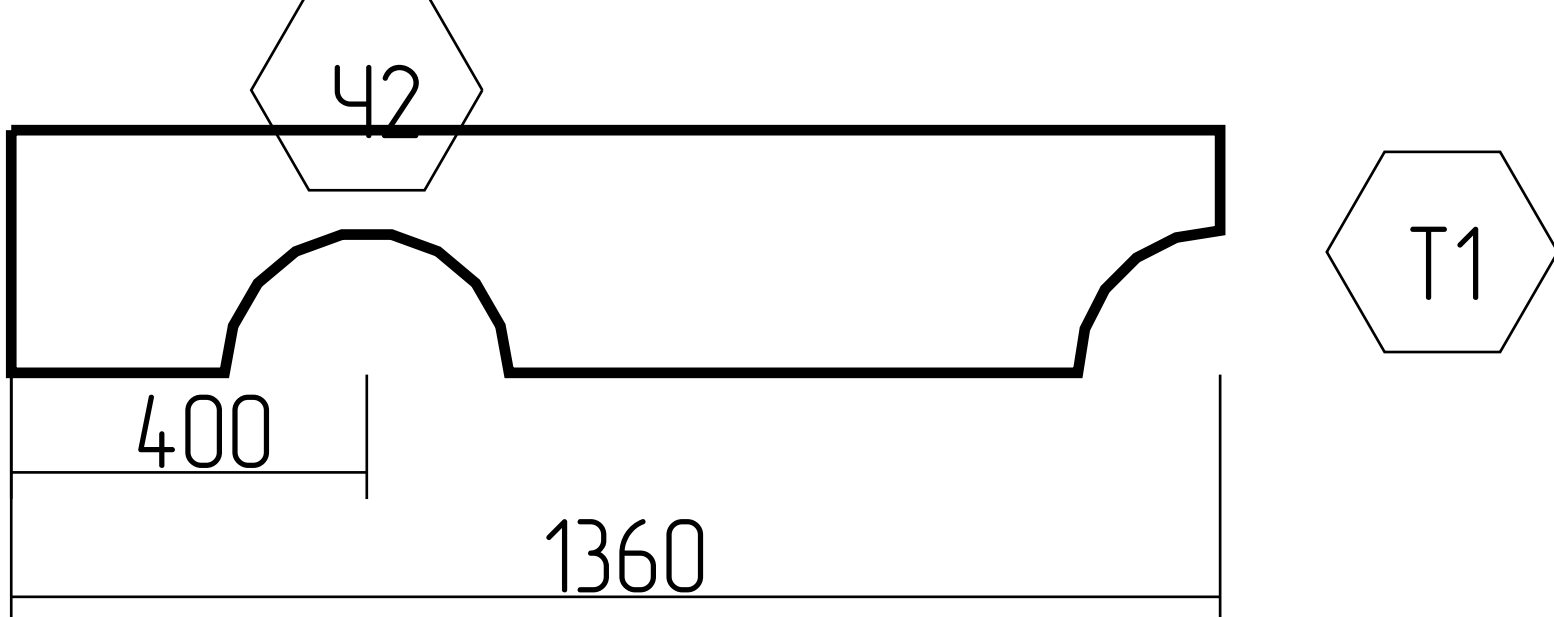

№	Марк.	Эскиз детали	Кол-во (шт)	Объем (м.куд.)
1	2.1-1, 2.12-2, 2.13-2, 2.13-3, 2.14-2, 2.14-3, 2.15-2, 2.15-3, 2.16-2, 2.16-3, 2.17-2, 2.17-3, 2.18-2, 2.18-3, 2.19-2, 2.19-3,		16	1.029
2	2.26-1		1	0.088
3	2.2-1, 2.3-1, 2.4-1, 2.5-1, 2.6-1, 2.7-1, 2.8-1,		7	0.676
4	2.20-1		1	0.097
5	2.9-1		1	0.109

Спецификация: ось 2

Лист

1:100

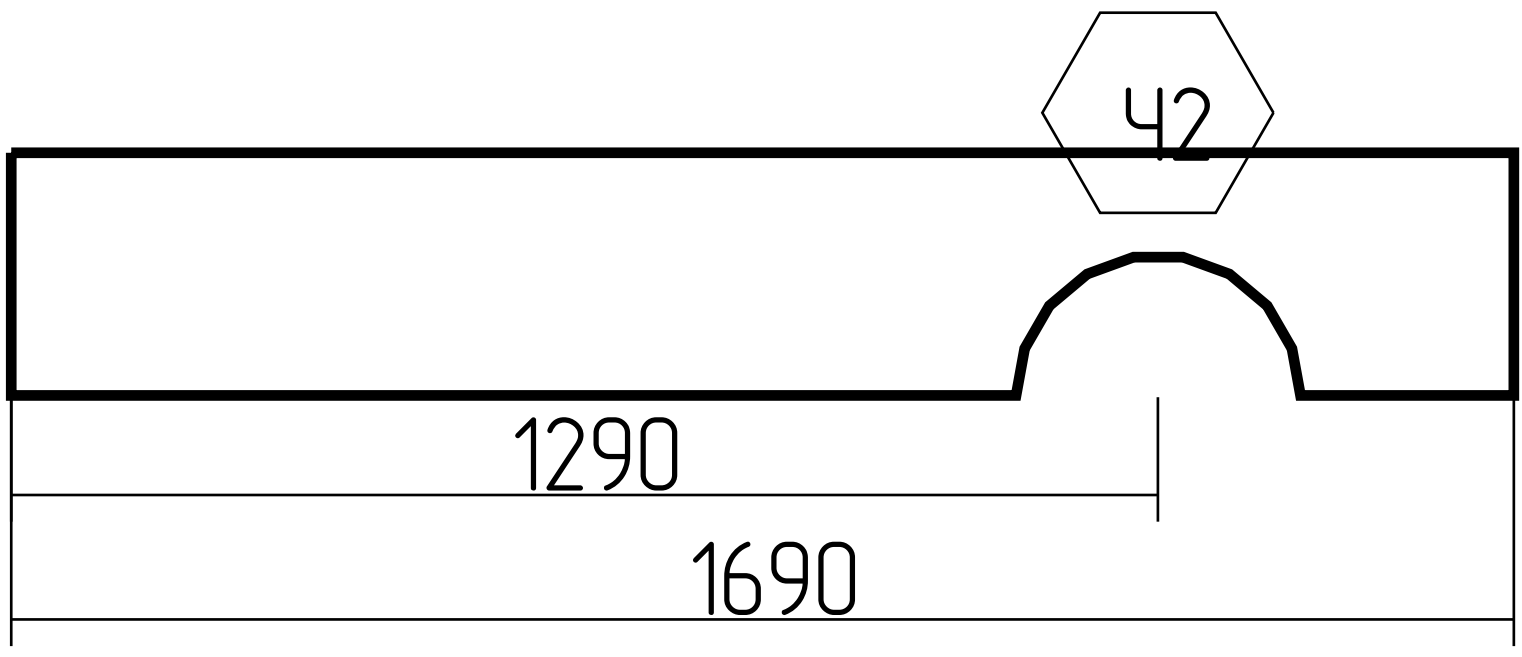
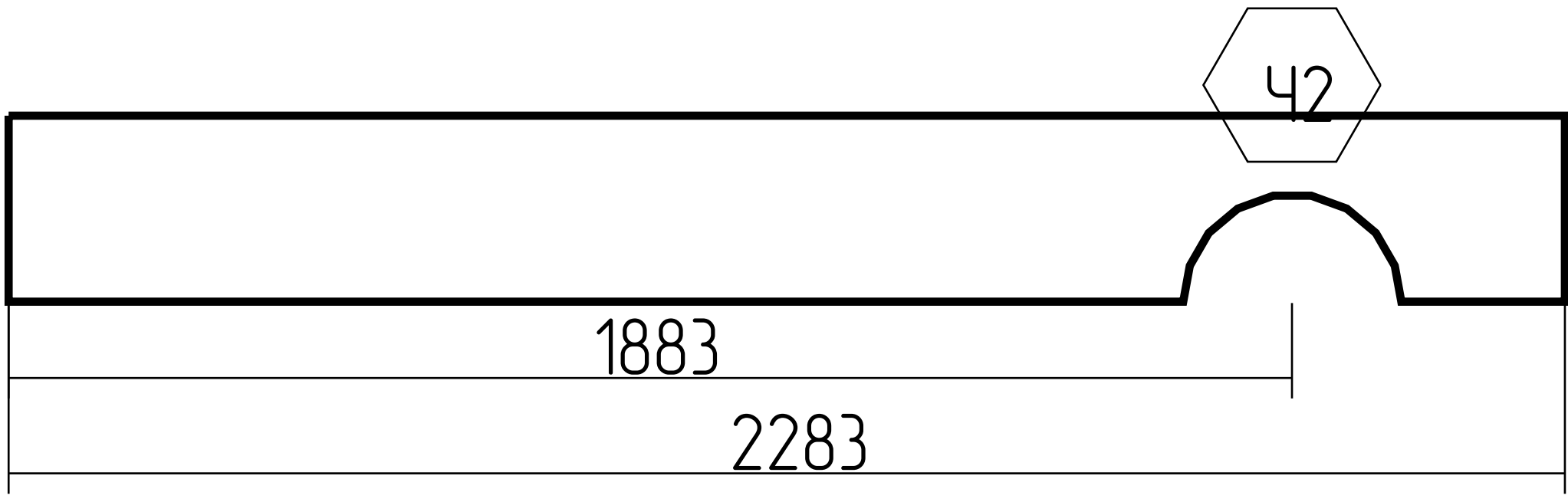
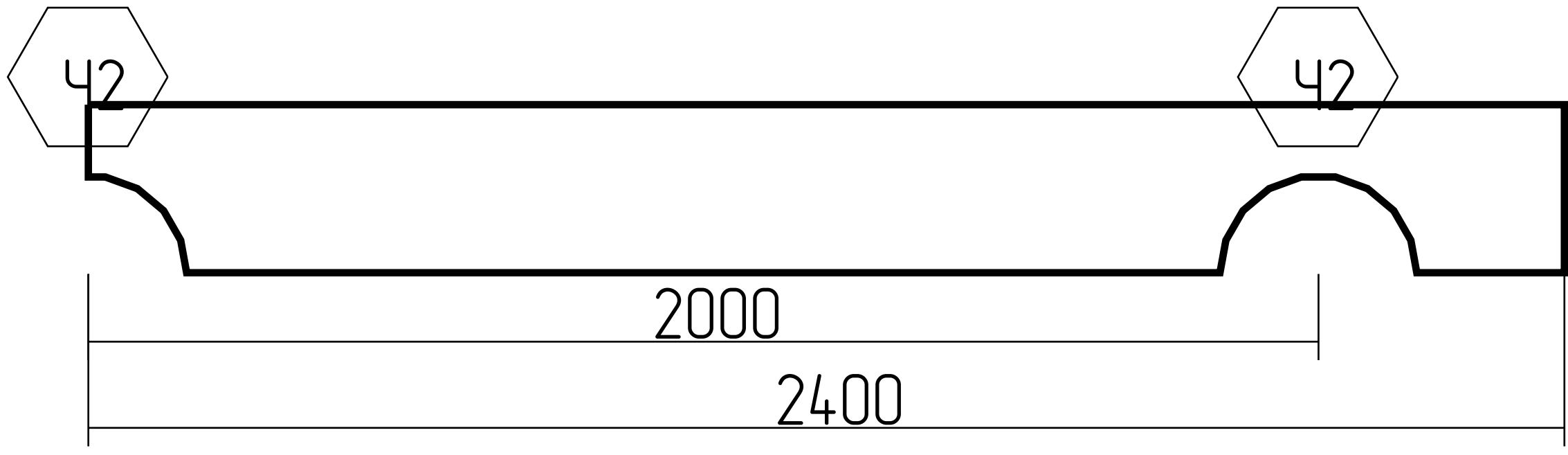
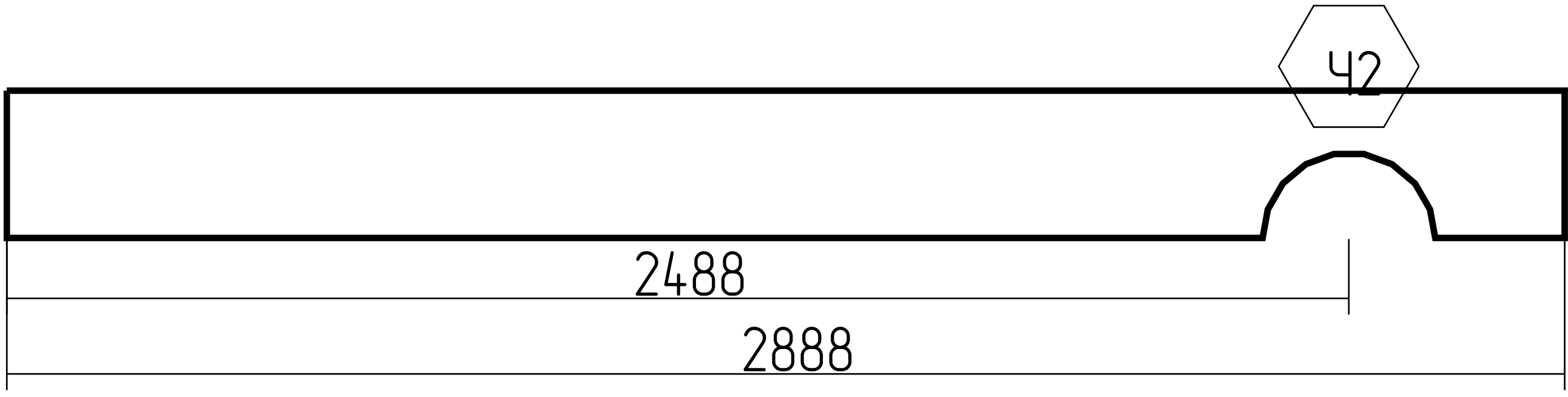
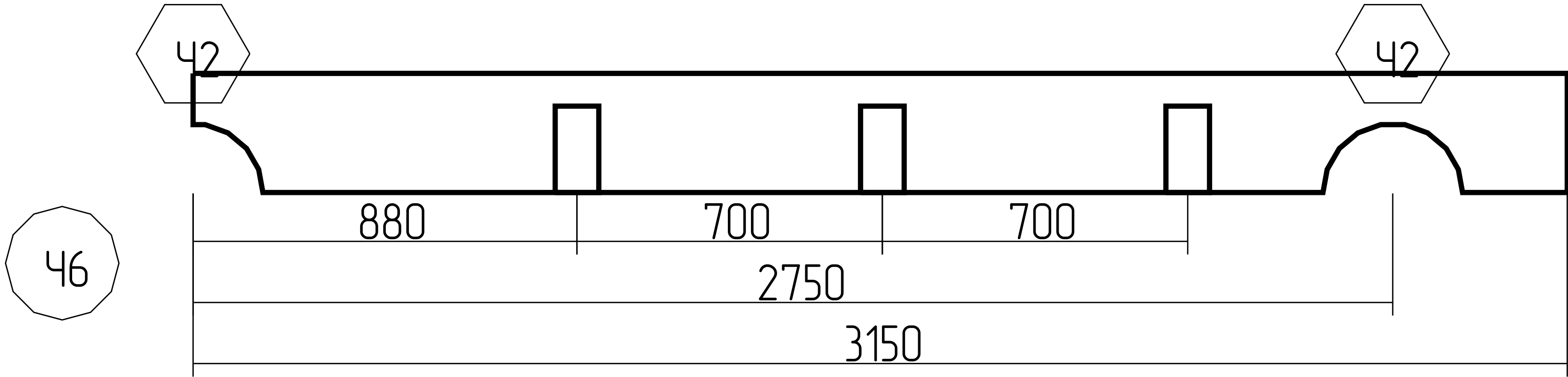
6	2.25-1		1	0.136
7	2.24-1		1	0.184
8	2.21-2		1	0.193
9	2.23-1		1	0.232
10	2.1-3		1	0.253

Спецификация: ось 2

Лист

1:100

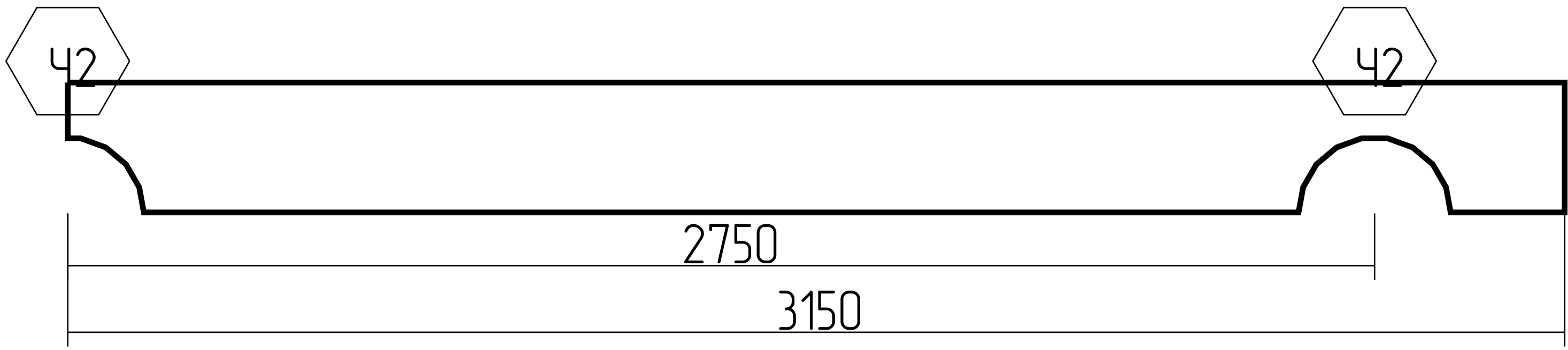
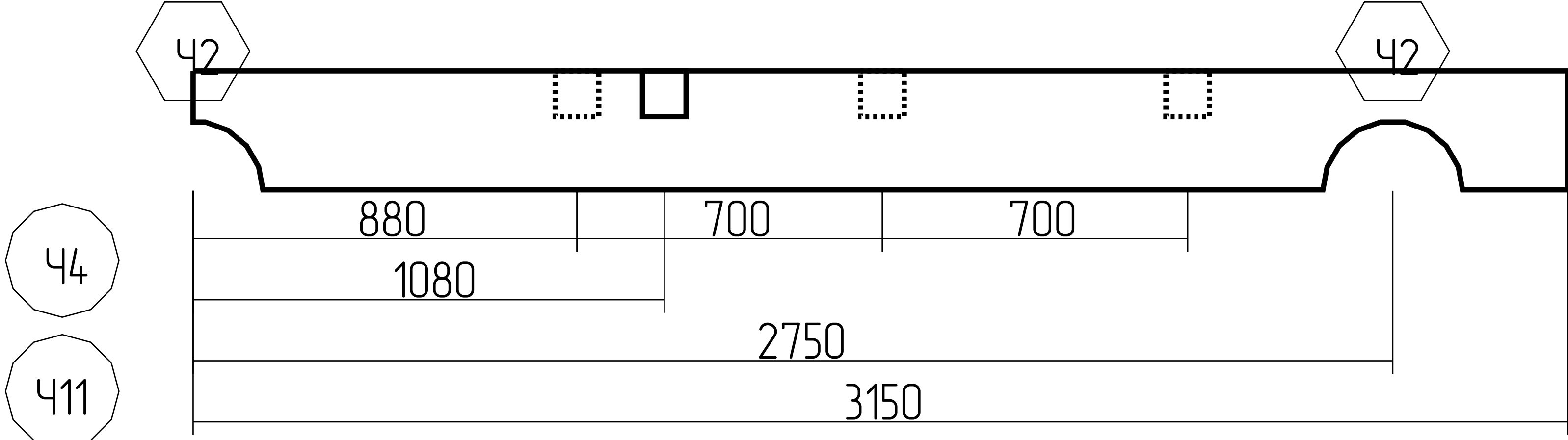
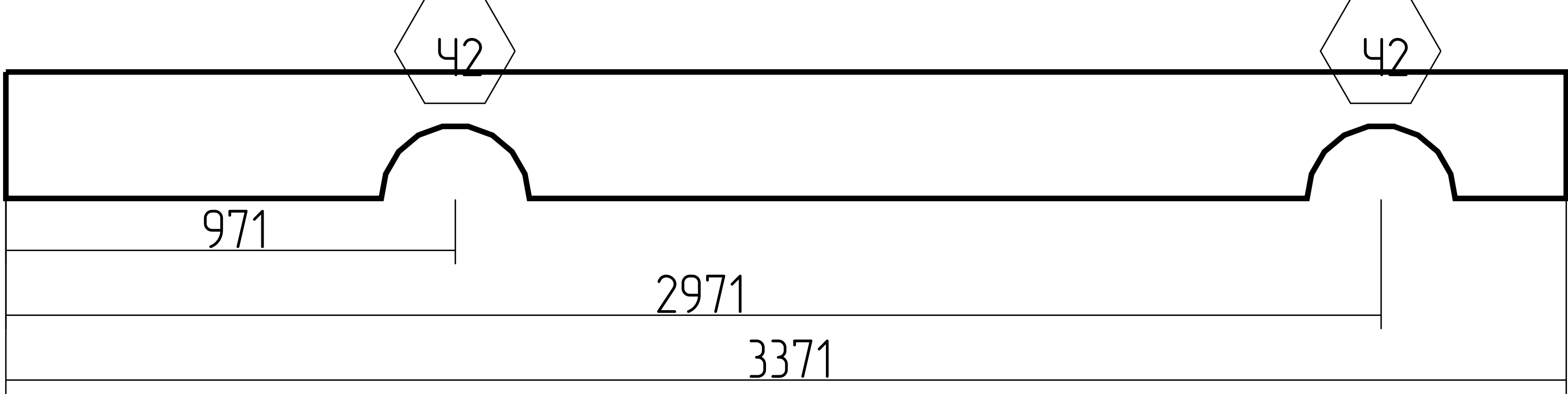
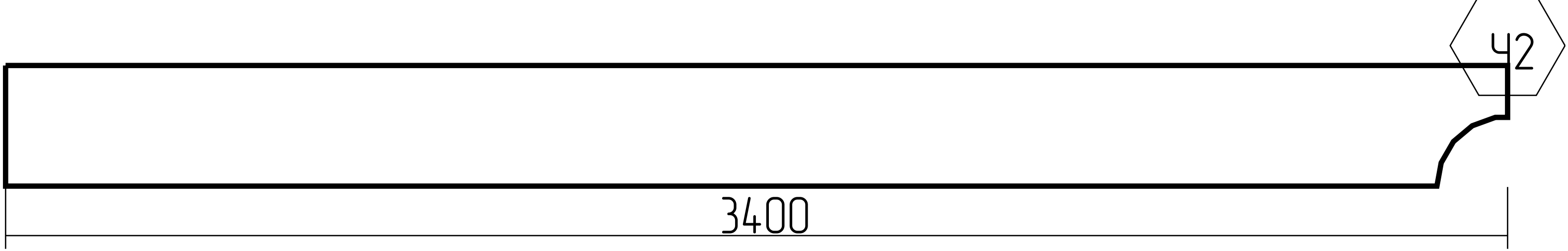
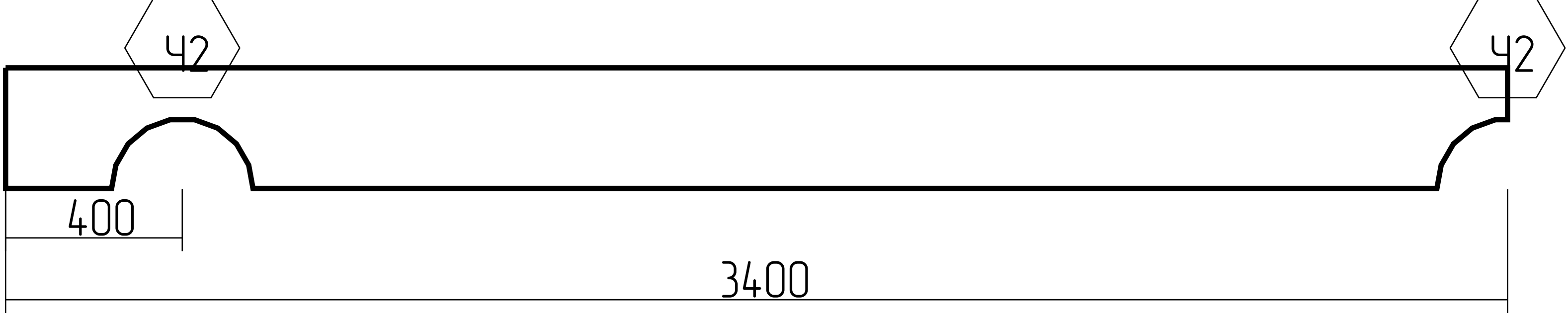
11	2.10-3		1	0.253
12	2.11-3		1	0.253
13	2.22-1		1	0.271
14	2.10-1		1	0.273
15	2.11-1		1	0.273

Спецификация: ось 2

Лист

1:100

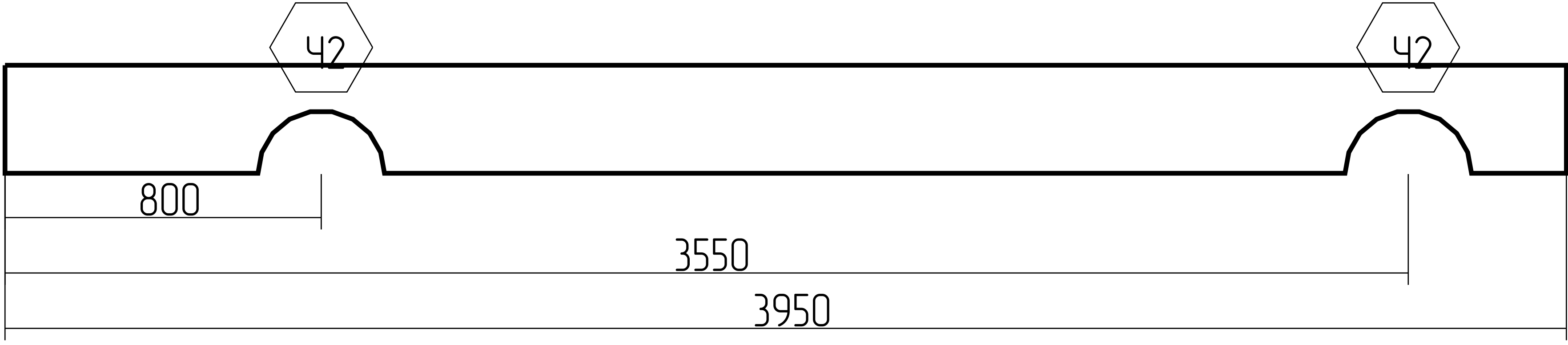
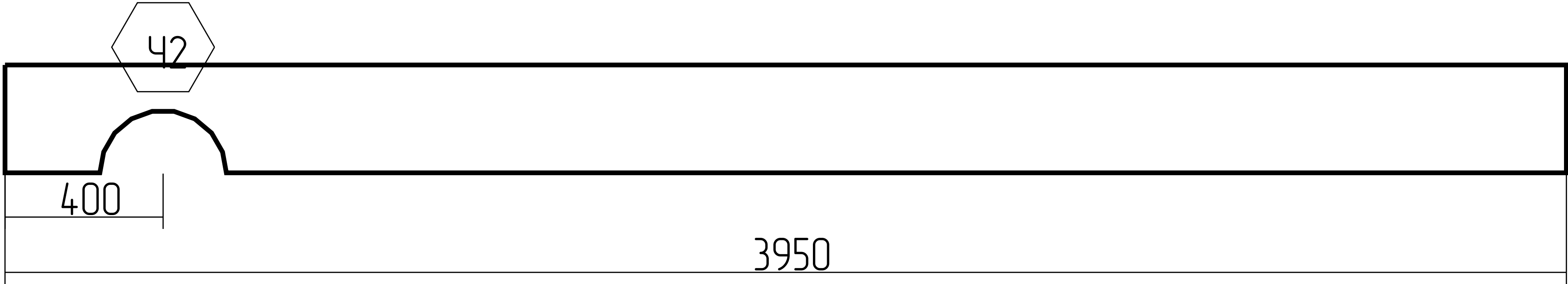
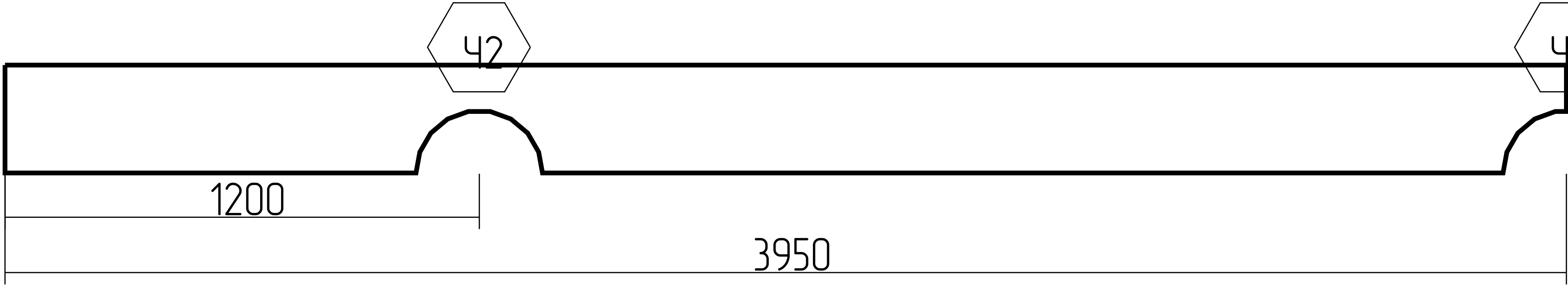
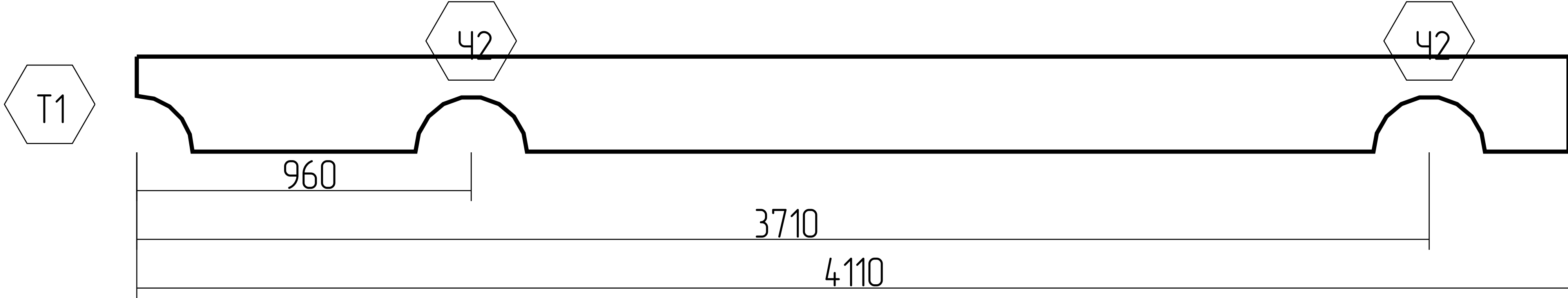
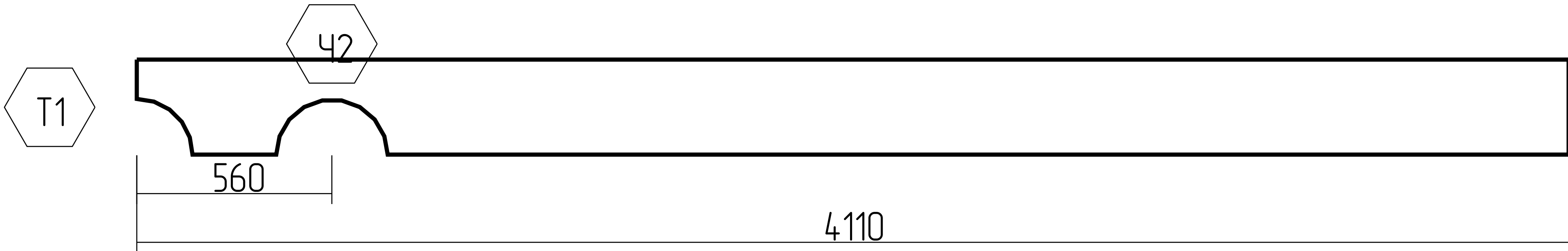
16	2.2-2, 2.3-2, 2.4-2, 2.5-2, 2.6-2, 2.7-2, 2.8-2,		7	2.224
17	2.13-1, 2.14-1, 2.15-1, 2.16-1, 2.17-1, 2.18-1		6	1.906
18	2.21-1		1	0.318
19	2.9-2		1	0.331
20	2.19-1		1	0.331

Спецификация: ось 2

Лист

1:100

21	2.10-2		1	0.382
22	2.11-2		1	0.382
23	2.1-2		1	0.414
24	2.20-2		1	0.414
25	2.12-1		1	0.446
Итого:			57	11.469



Спецификация: ось 2

Лист

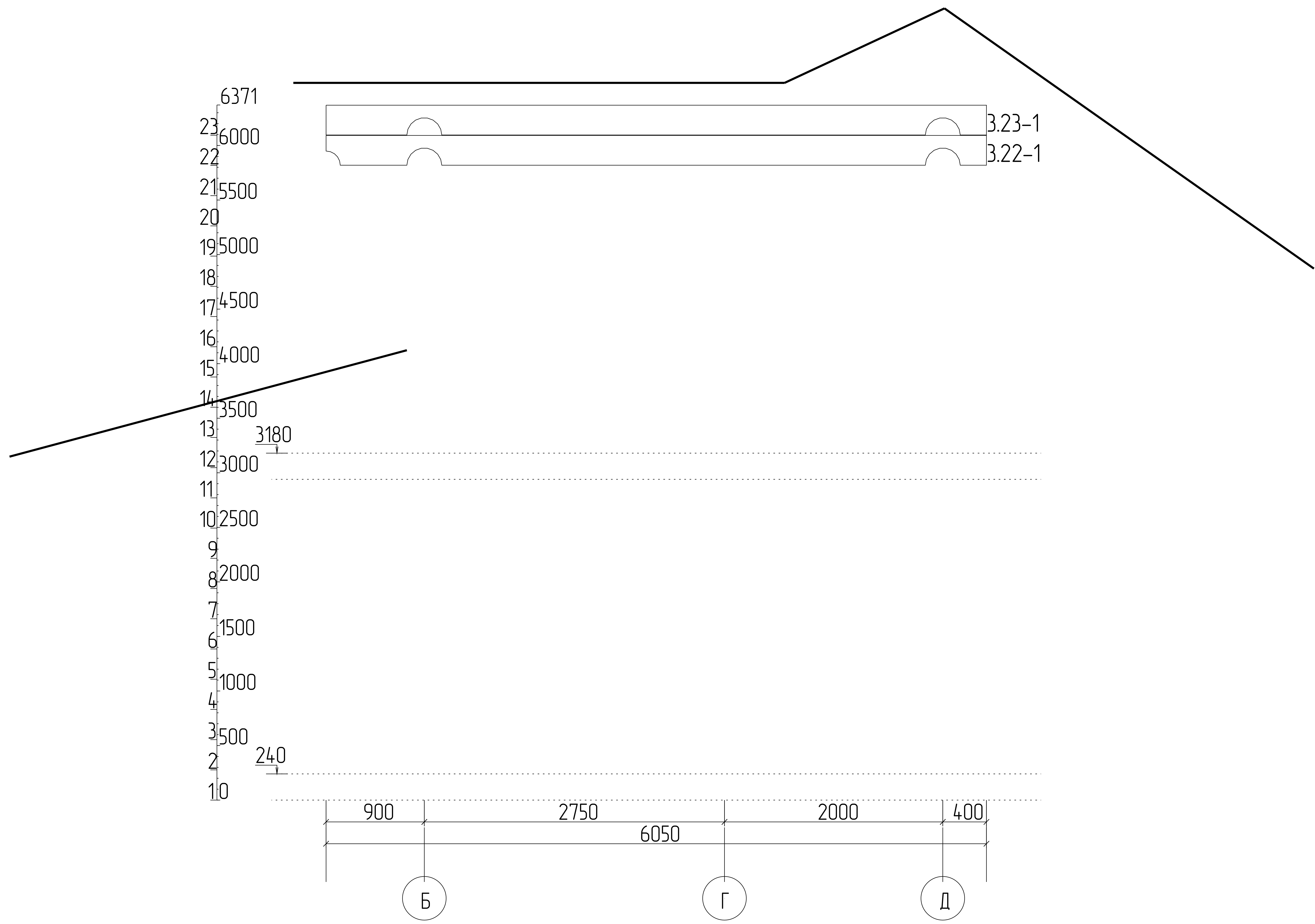
1:100

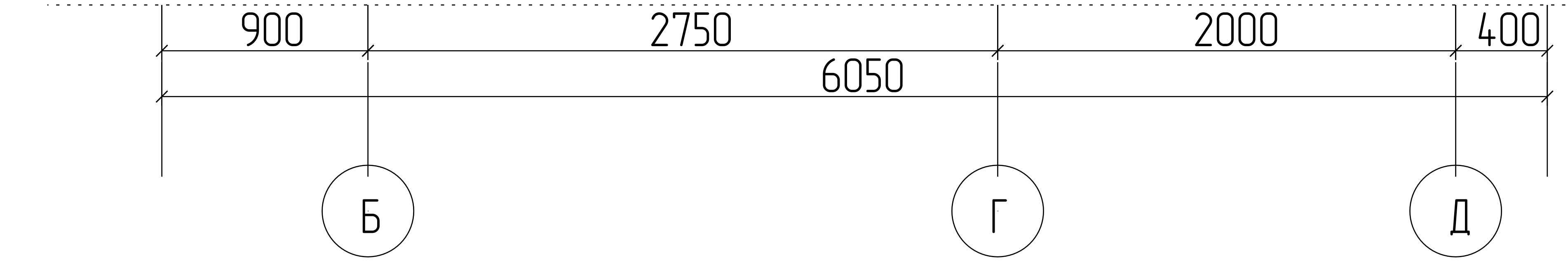

6371  
23 6000  
22  
21 5500  
20  
19 5000  
18  
17 4500  
16  
15 4000  
14  
13 3500  
12 3000  
11  
10 2500  
9  
8 2000  
7  
6 1500  
5  
4 1000  
3 500  
2 240  
10



3.23-1  
3.22-1

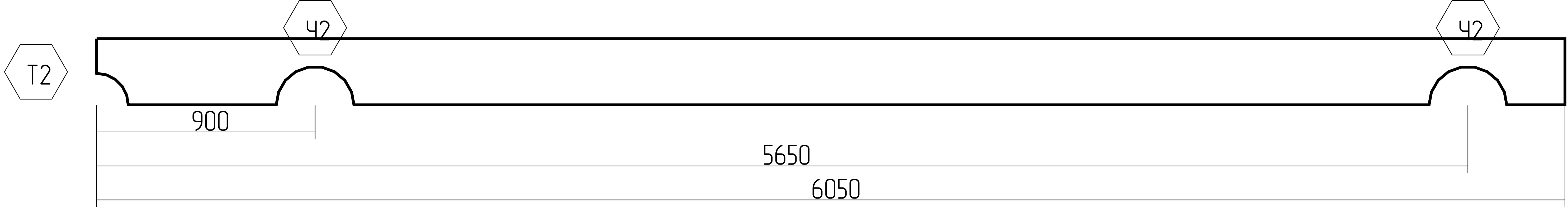
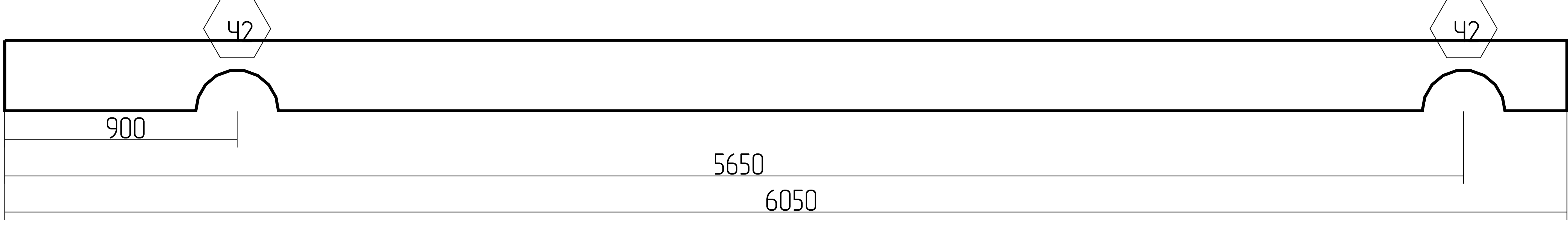

План порядовки: ось 3

№	Марк.	Эскиз детали	Кол-во (шт)	Объем (м.куб.)
1	3.22-1		1	0.487
2	3.23-1		1	0.487
Итого:			2	0.973

Спецификация: ось 3

Лист

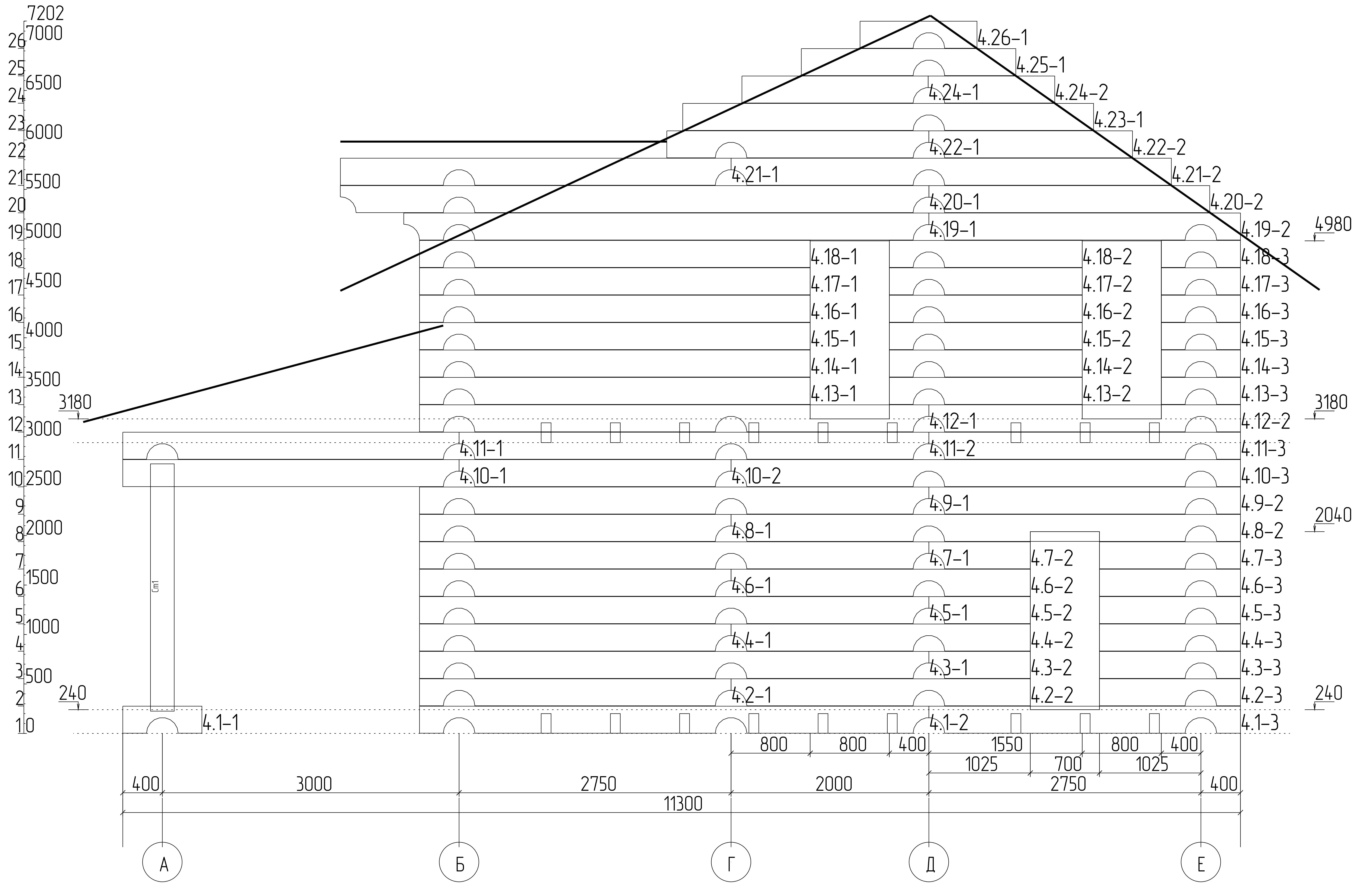
1:100



												л/см
												1:50

План порядовки: ось 4

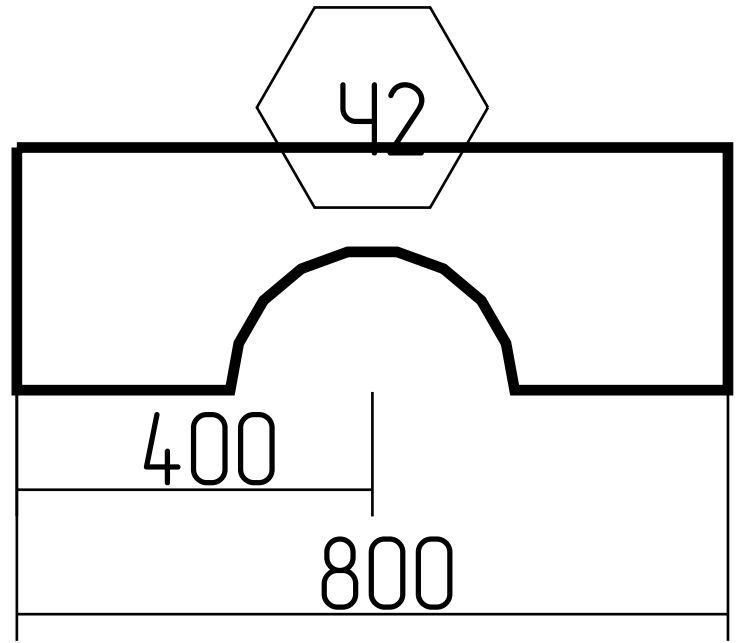
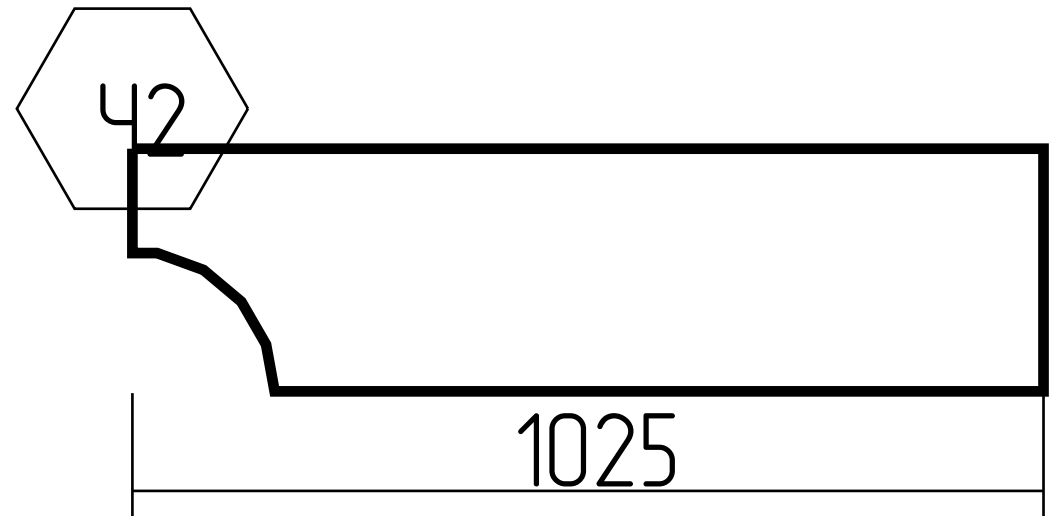
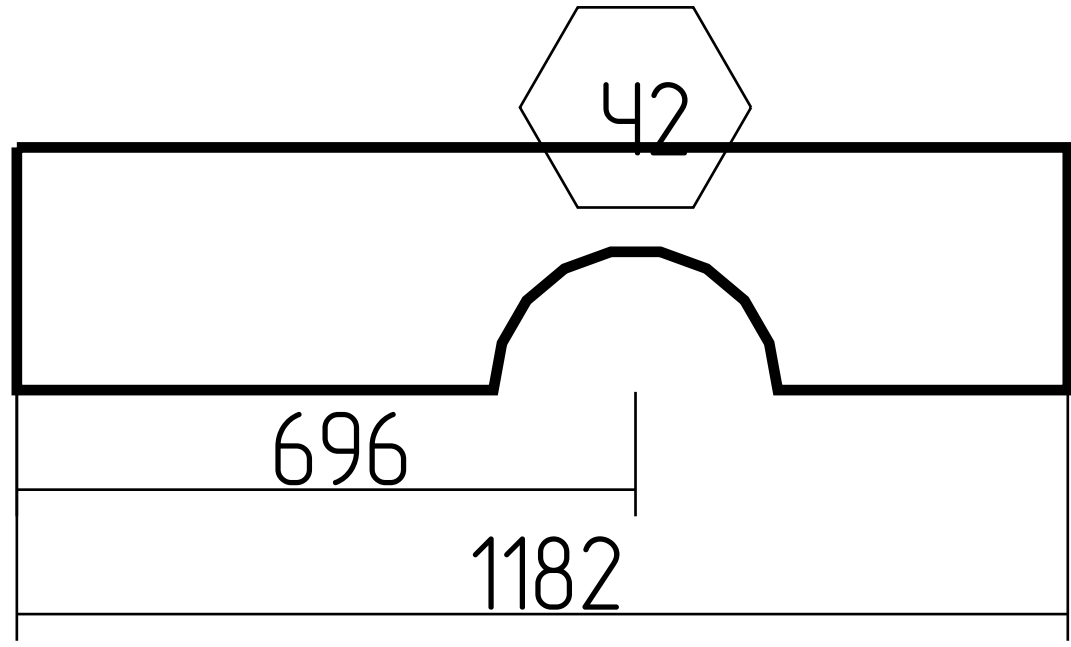
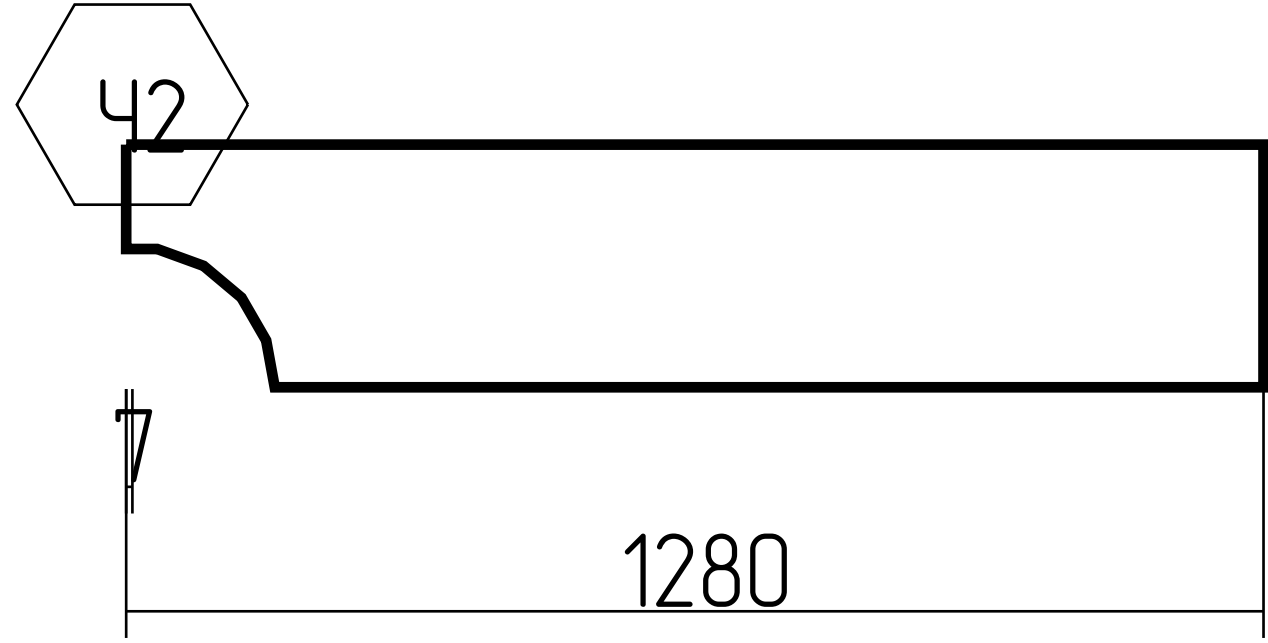
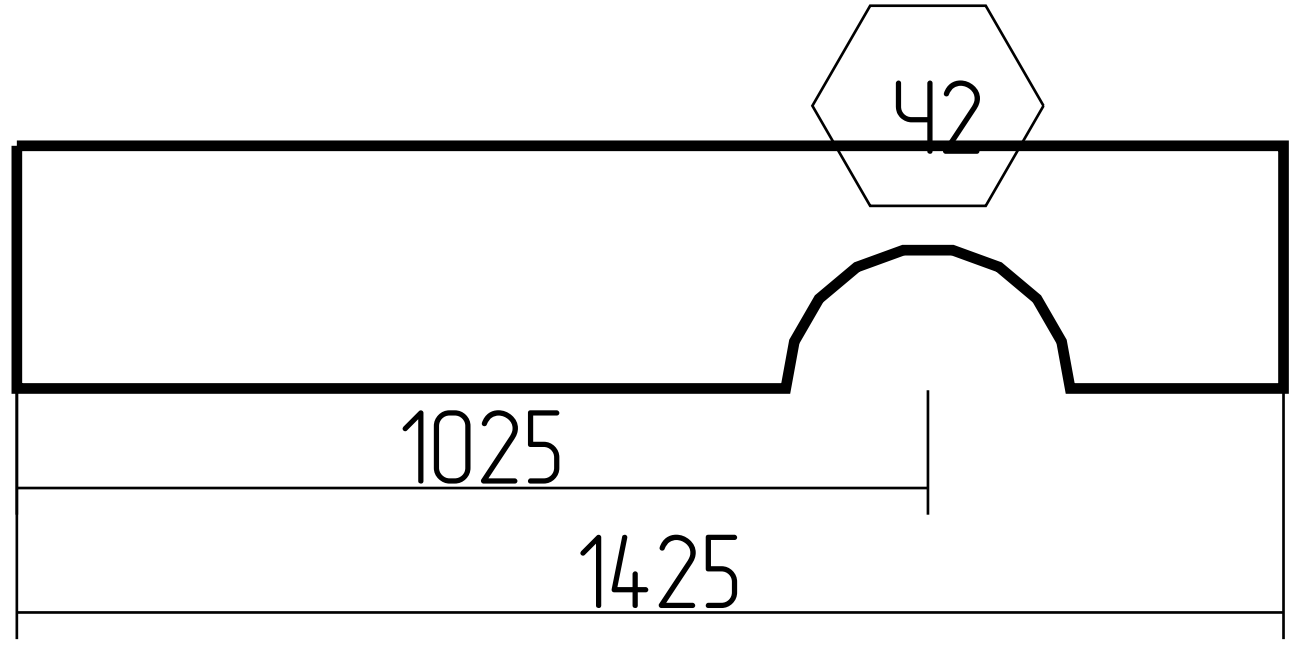
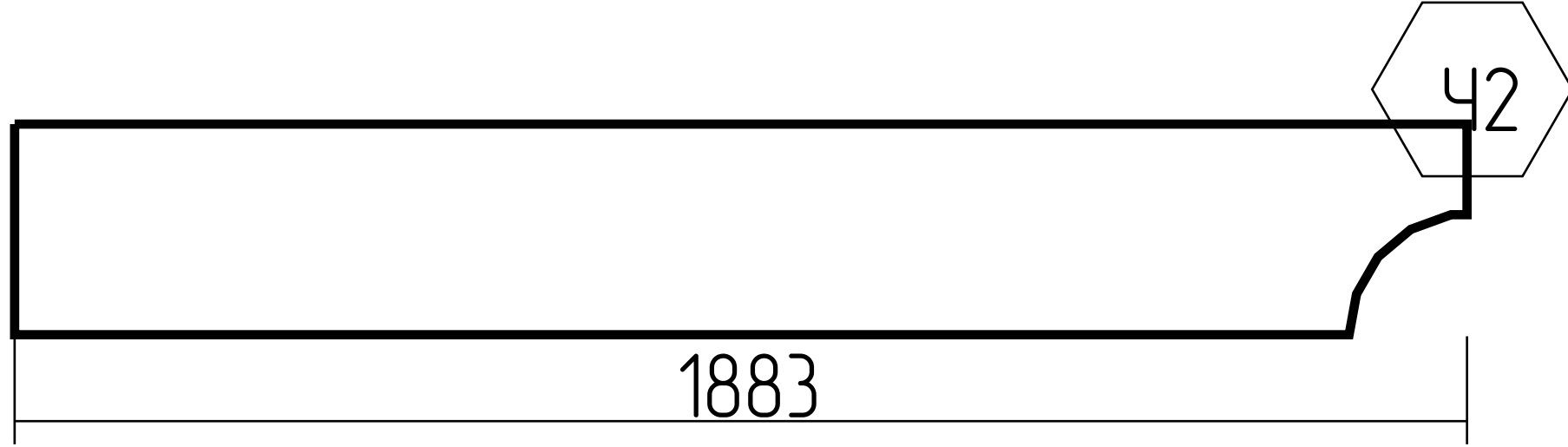

№	Марк.	Эскиз детали	Кол-во (шт)	Объем (м.куд.)
1	4.1-1, 4.13-3, 4.14-3, 4.15-3, 4.16-3, 4.17-3, 4.18-3,		7	0.450
2	4.3-2, 4.5-2, 4.7-2		3	0.247
3	4.26-1		1	0.095
4	4.24-2		1	0.103
5	4.2-3, 4.3-3, 4.4-3, 4.5-3, 4.6-3, 4.7-3		6	0.688
6	4.24-1		1	0.151
Спецификация: ось 4				Лист 1:100

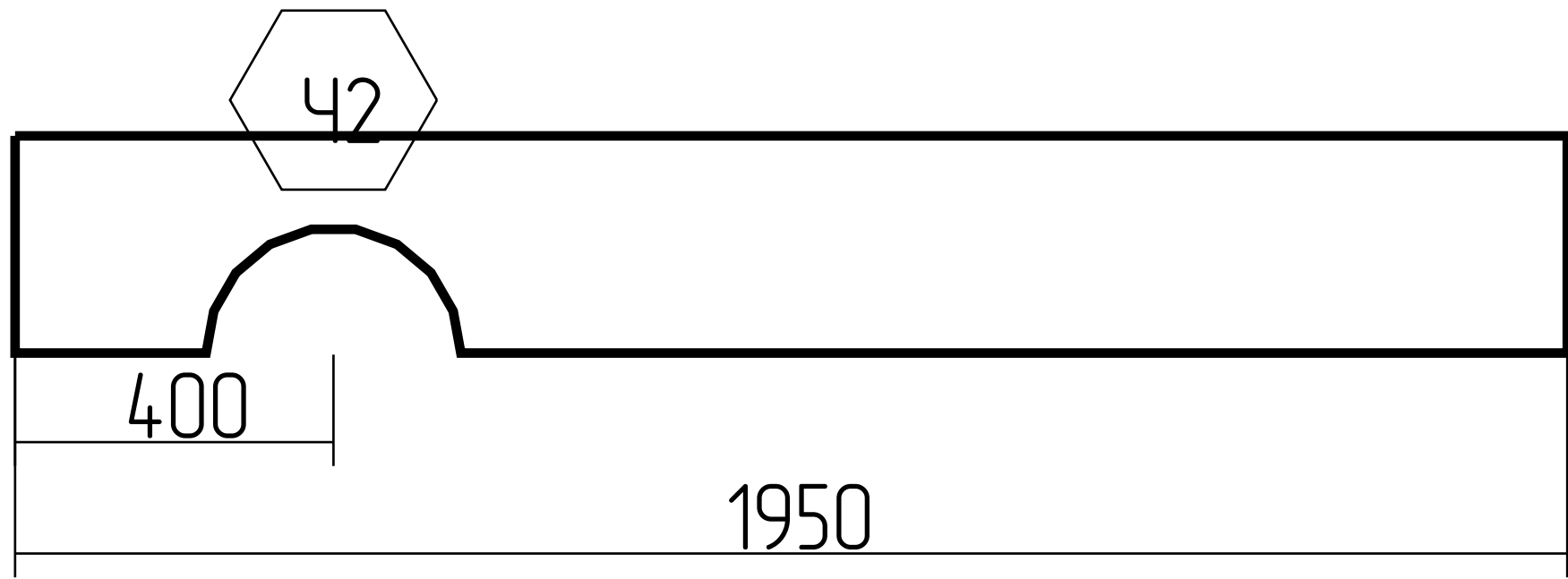
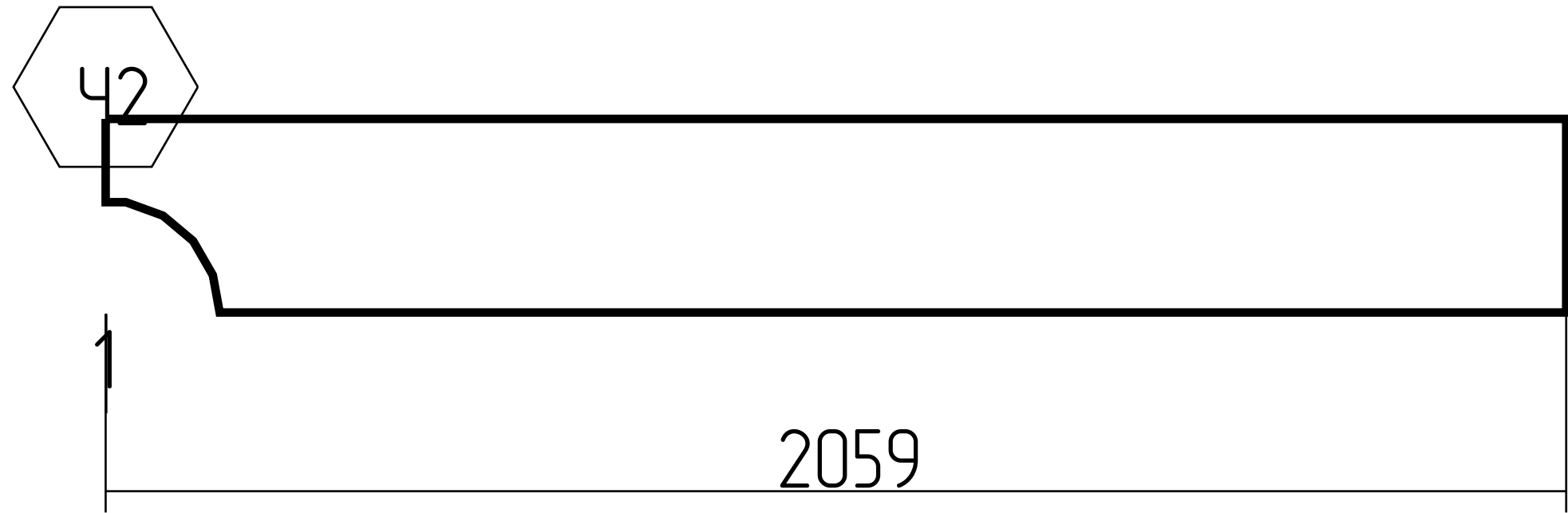
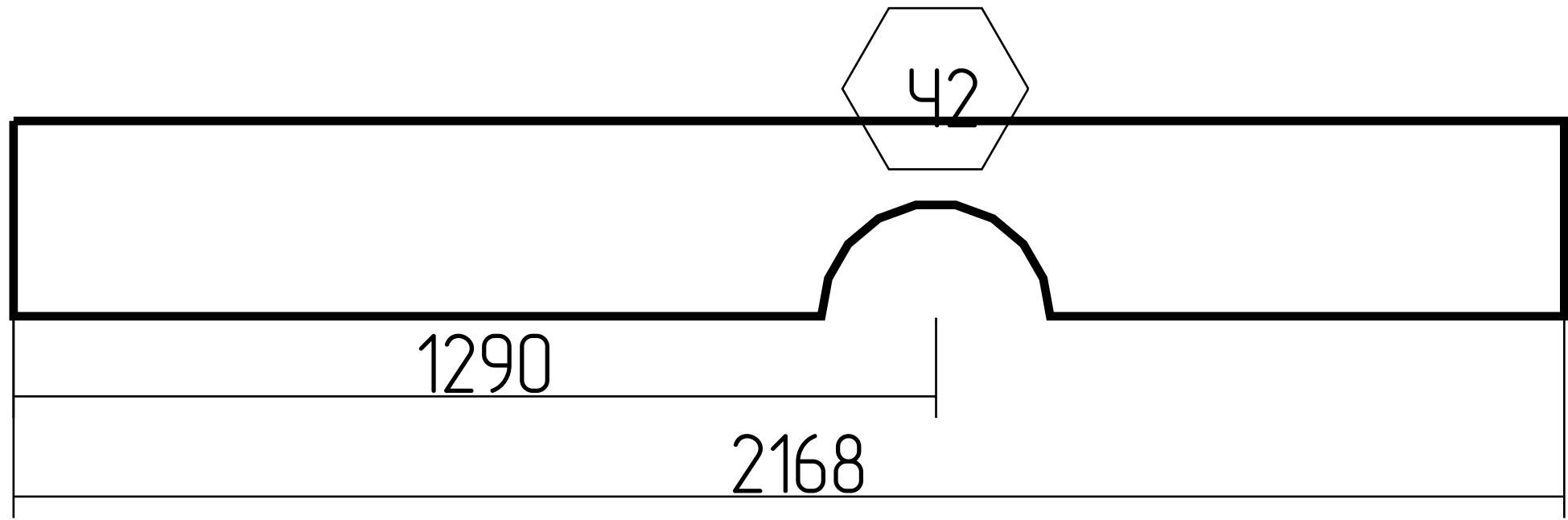
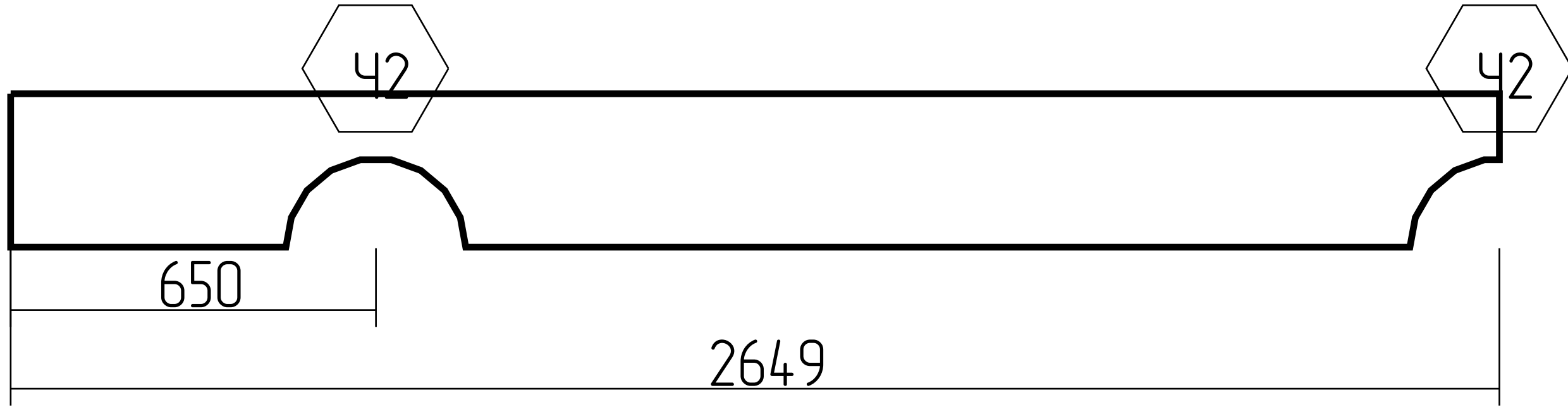
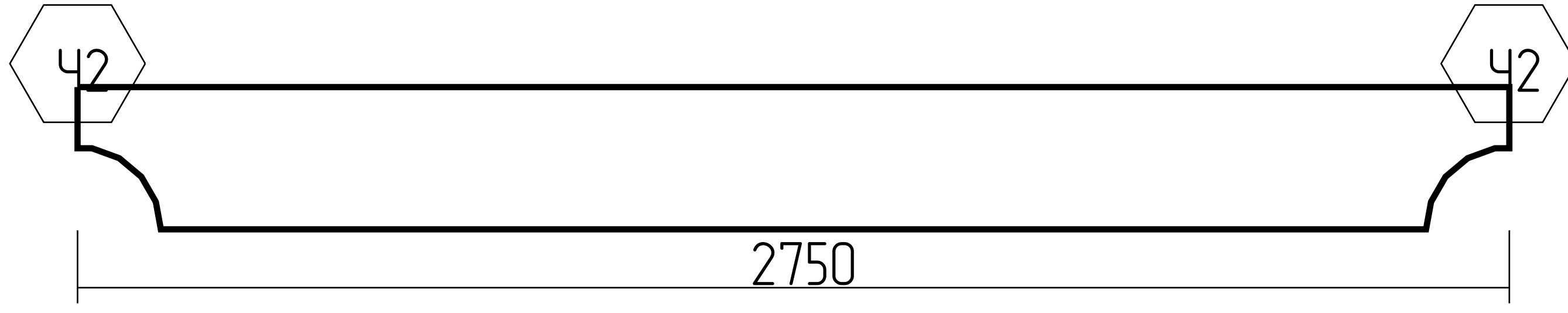
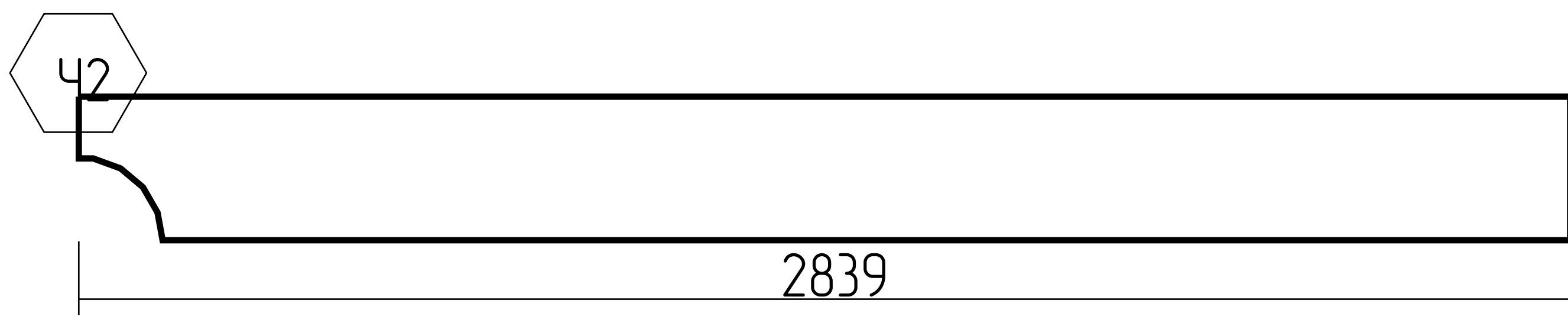
7	4.13-2, 4.14-2, 4.15-2, 4.16-2, 4.17-2, 4.18-2		6	0.941
8	4.22-2		1	0.166
9	4.25-1		1	0.174
10	4.22-1		1	0.213
11	4.10-2		1	0.221
12	4.20-2		1	0.228

Спецификация: ось 4

Лист

1:100

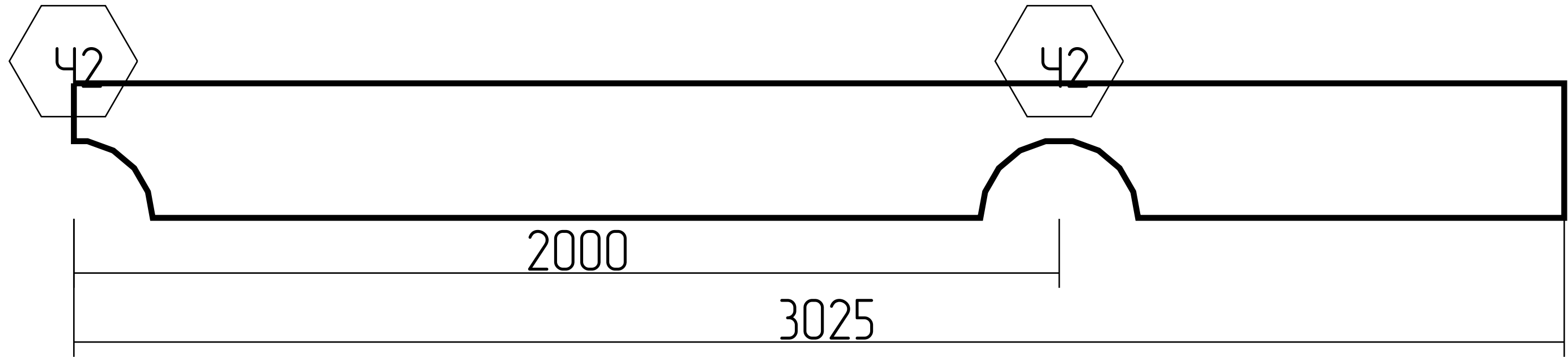
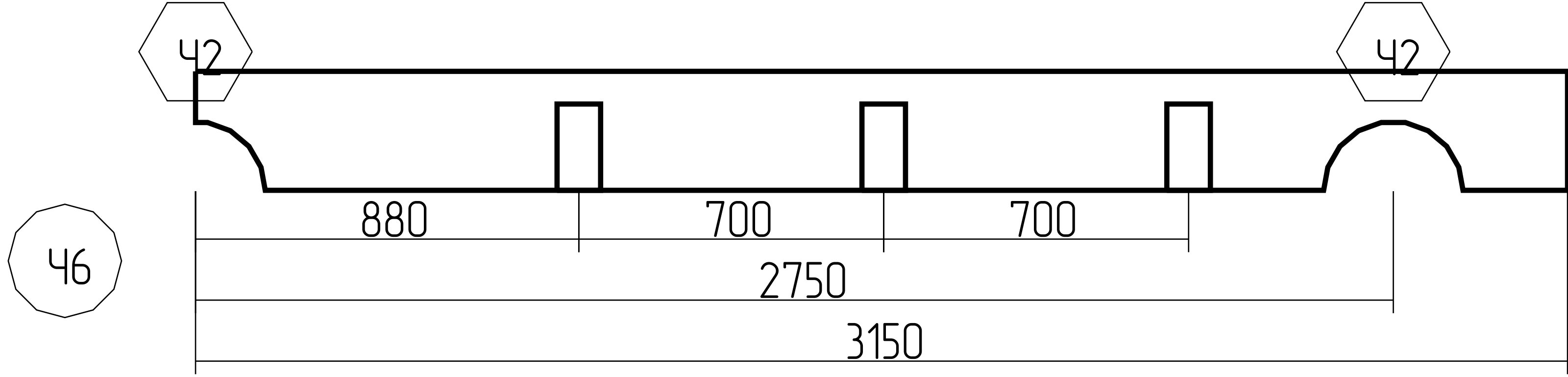
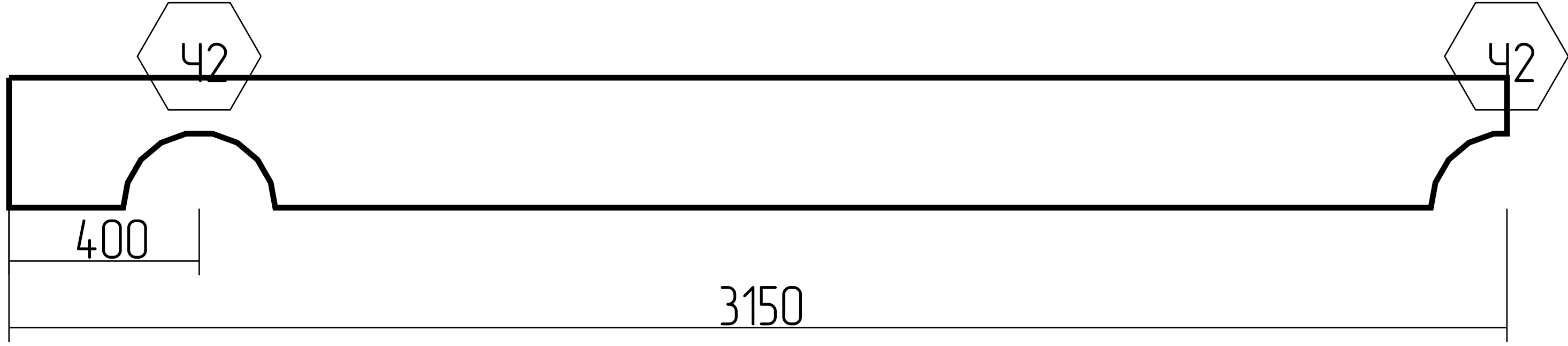
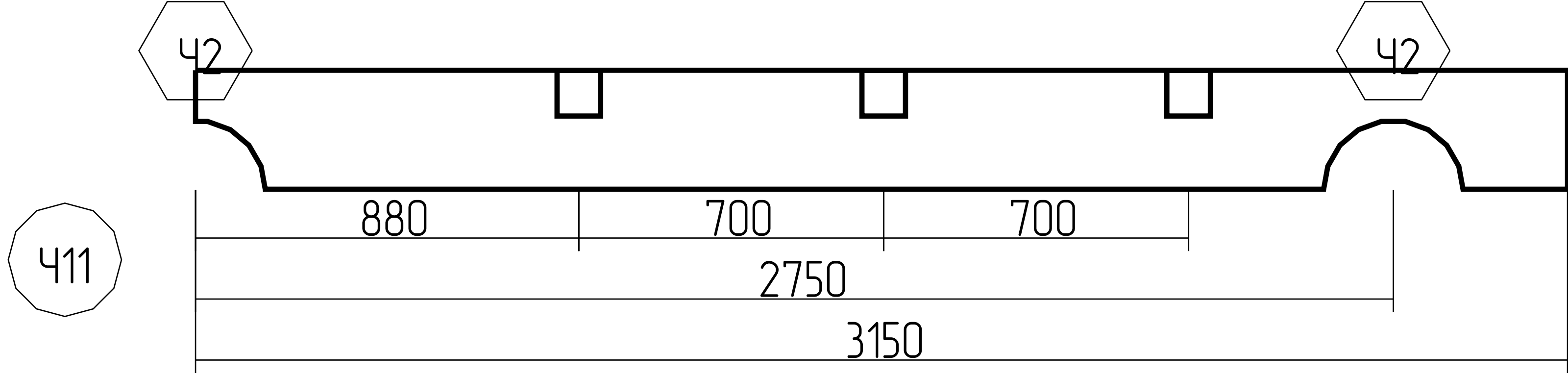
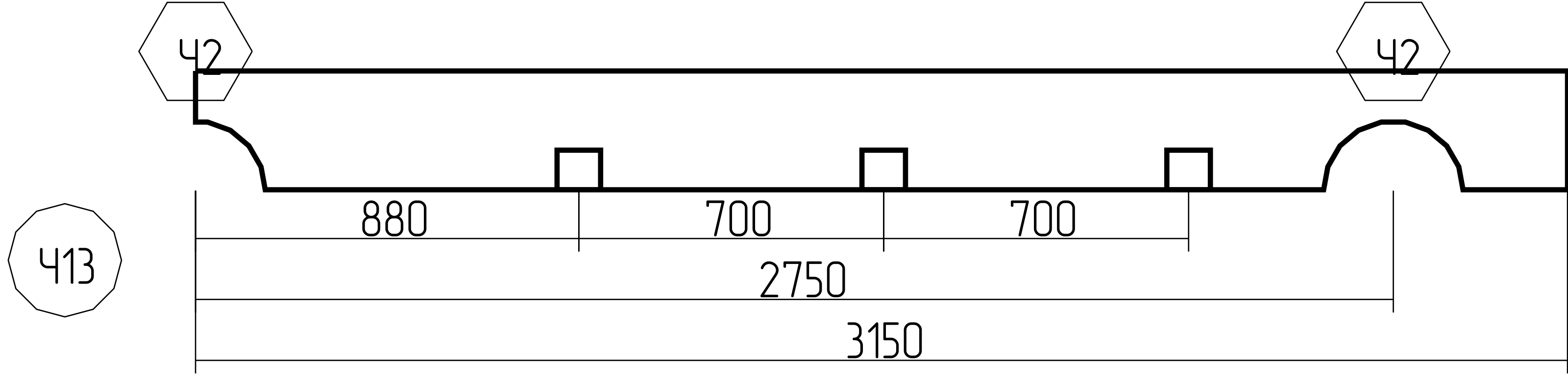
13	4.2-2, 4.4-2, 4.6-2		3	0.730
14	4.1-3		1	0.253
15	4.2-1, 4.4-1, 4.6-1, 4.8-1, 4.9-2, 4.19-2		6	1.520
16	4.11-3		1	0.253
17	4.12-2		1	0.253

Спецификация: ось 4

Лист

1:100

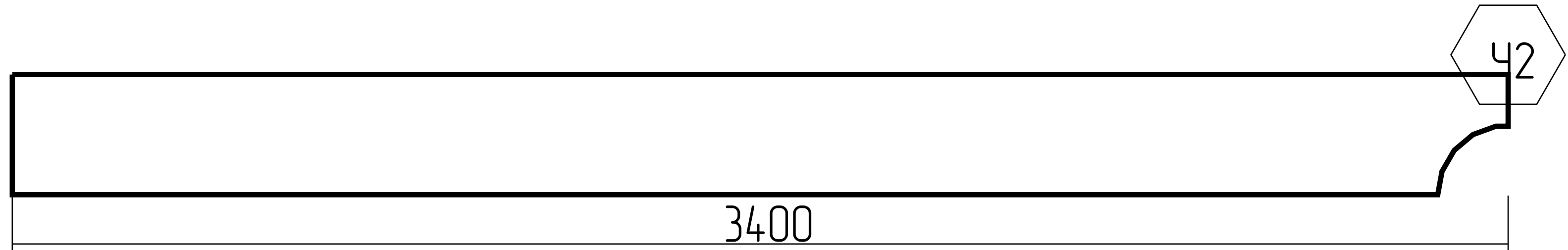
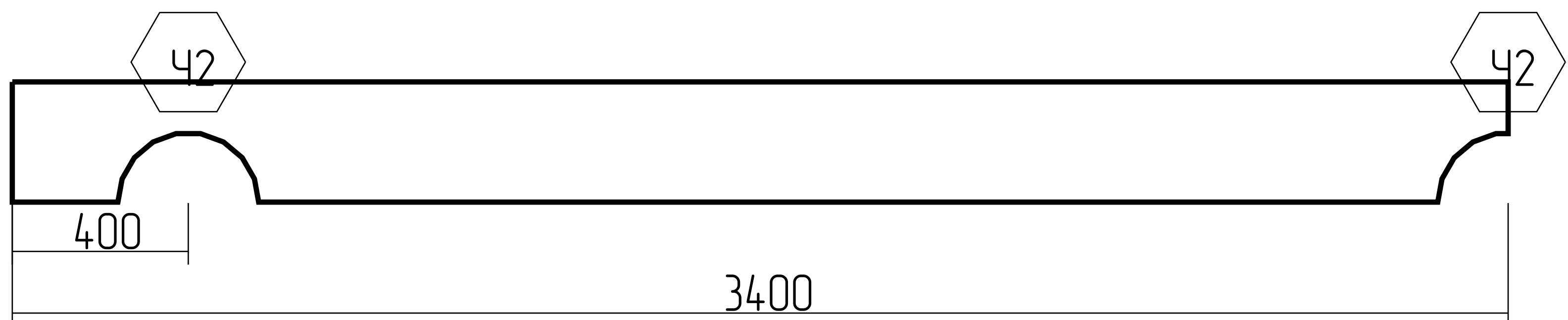
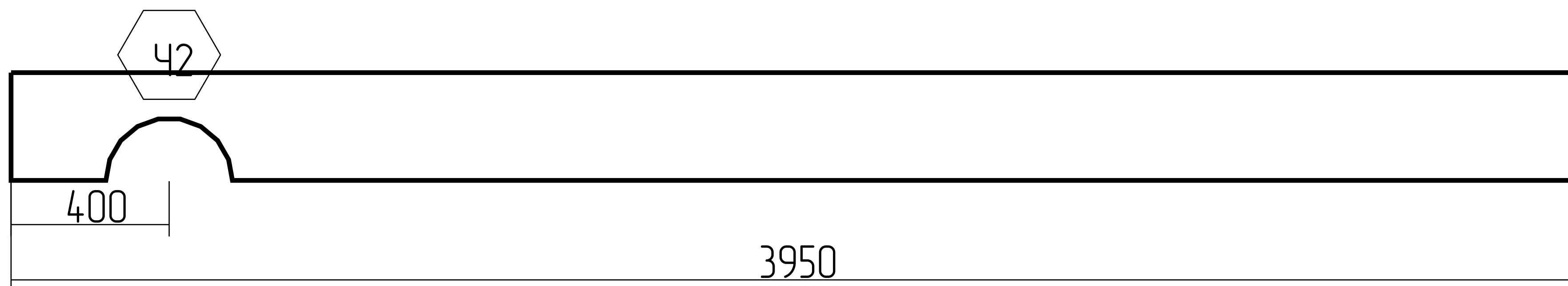
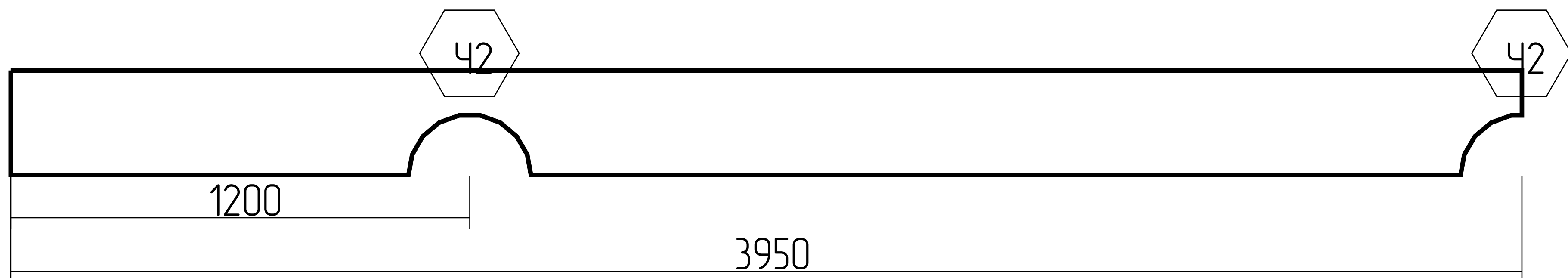
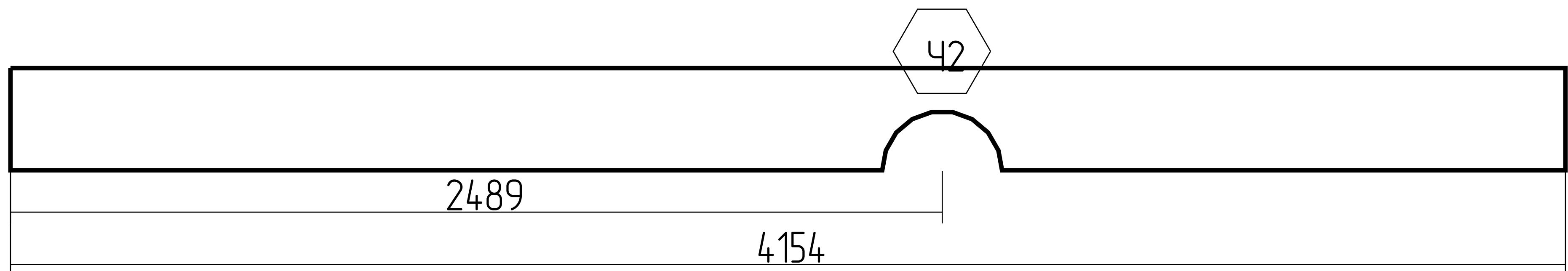
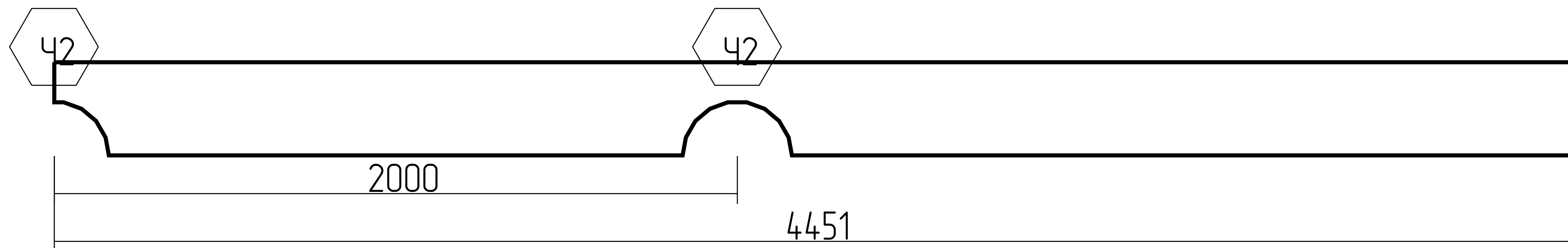
18	4.10-1		1	0.273
19	4.11-1		1	0.273
20	4.13-1, 4.14-1, 4.15-1, 4.16-1, 4.17-1, 4.18-1		6	1.906
21	4.21-1		1	0.318
22	4.23-1		1	0.334
23	4.21-2		1	0.358

Спецификация: ось 4

Лист

1:100

24	4.11-2		1	0.382
25	4.1-2		1	0.414
26	4.3-1, 4.5-1, 4.7-1, 4.8-2, 4.9-1, 4.10-3		6	2.485
27	4.12-1		1	0.414
28	4.19-1		1	0.427

Спецификация: ось 4

Лист  
1:100

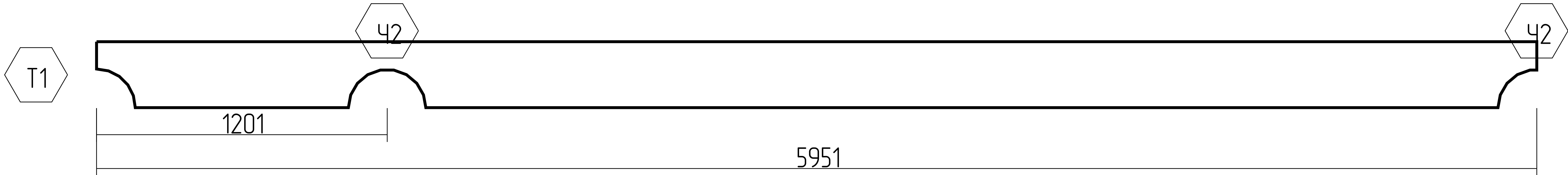
29	4.20-1		1	0.479
			Итого:	64 14.752

				Спецификация: ось 4	Лист
					1:100

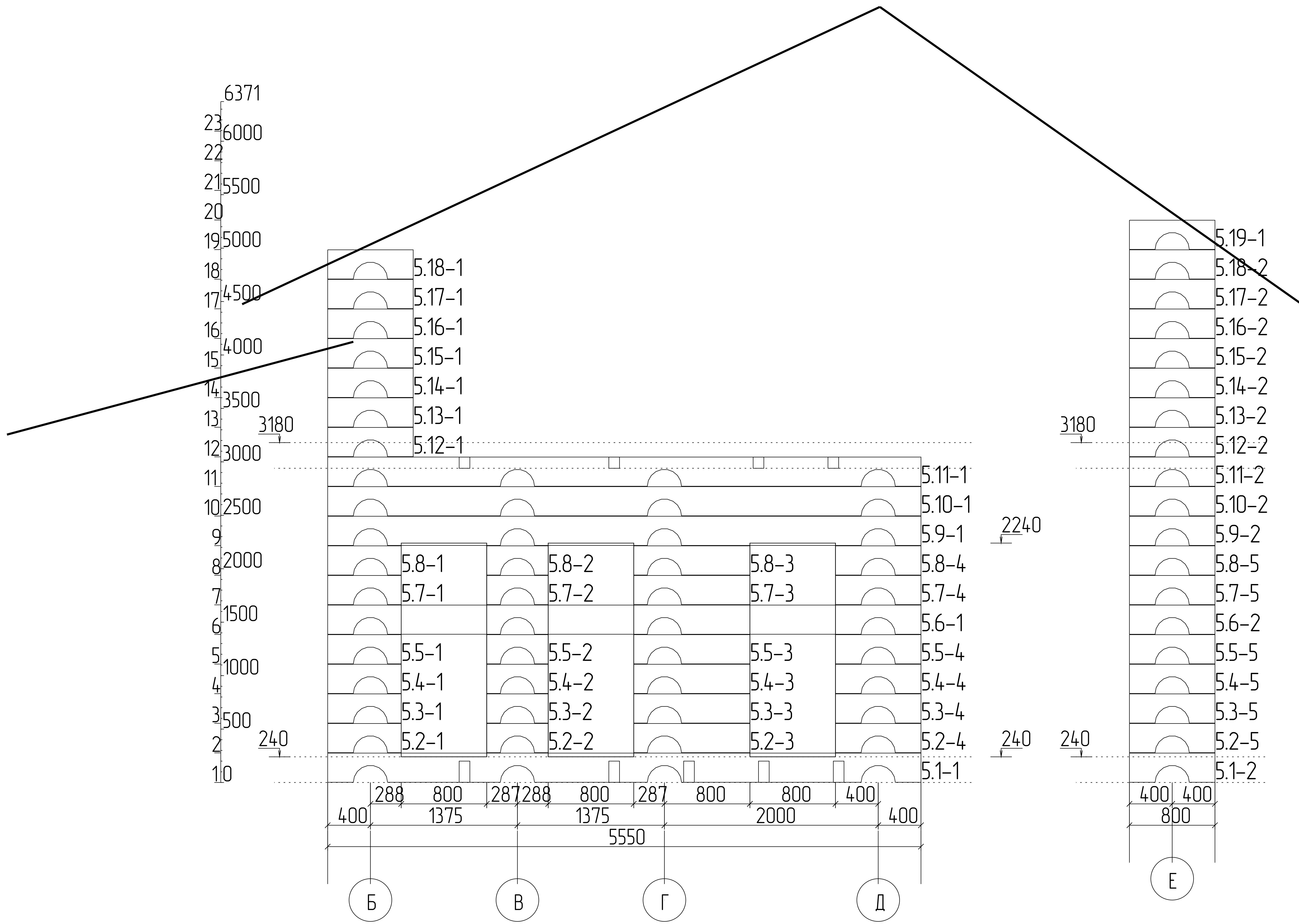

План порядовки: ось 5

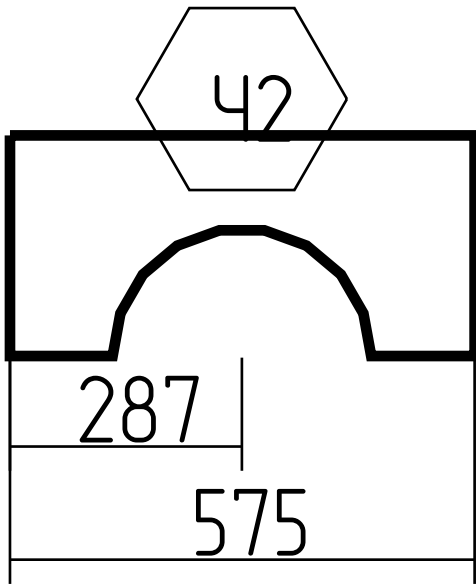
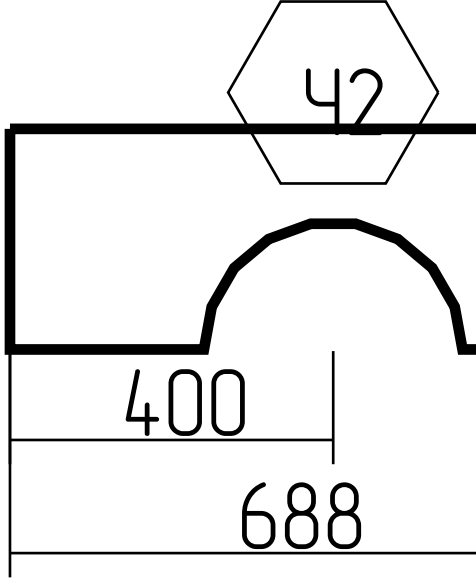
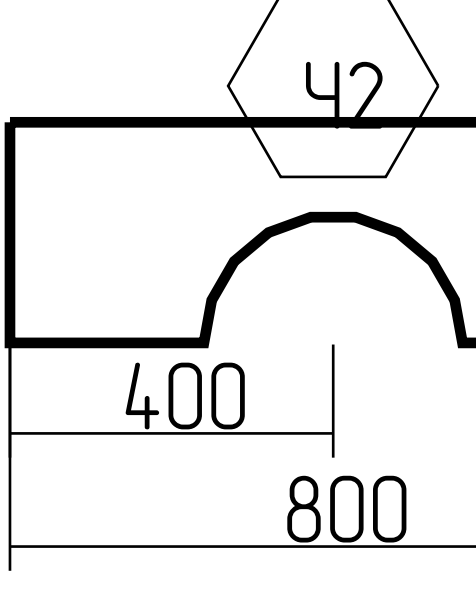
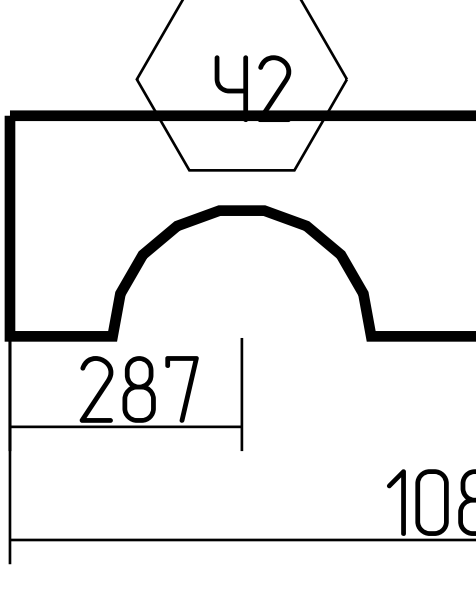
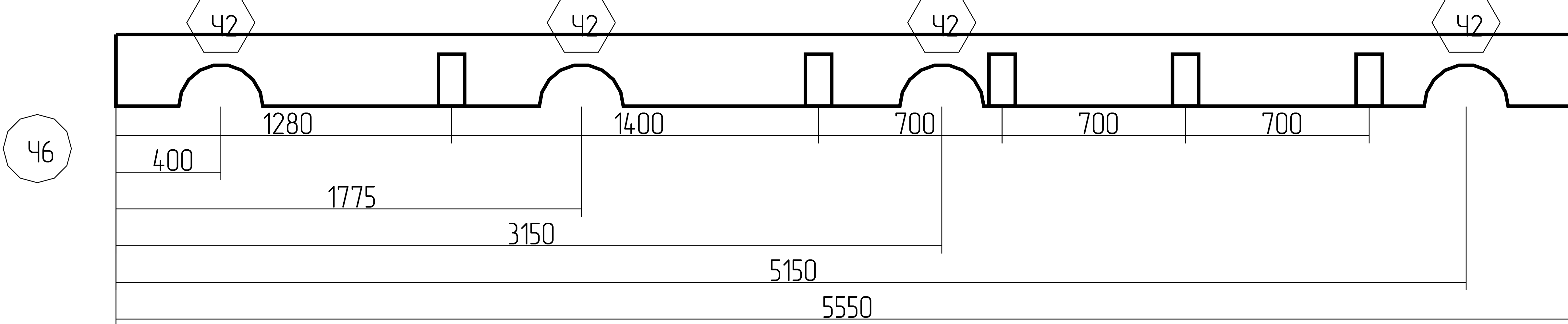
№	Марк.	Эскиз детали	Кол-во (шт)	Объем (м.куб.)
1	5.2-2, 5.3-2, 5.4-2, 5.5-2, 5.7-2, 5.8-2		6	0.277
2	5.2-1, 5.3-1, 5.4-1, 5.5-1, 5.7-1, 5.8-1		6	0.332
3	5.2-4, 5.3-4, 5.4-4, 5.5-4, 5.7-4, 5.8-4, 5.12-1, 5.13-1, 5.14-1, 5.15-1, 5.16-1, 5.17-1, 5.18-1, 5.1-2, 5.2-5, 5.3-5, 5.4-5, 5.5-5, 5.6-2, 5.7-5, 5.8-5, 5.9-2, 5.10-2, 5.11-2, 5.12-2, 5.13-2, 5.14-2, 5.15-2, 5.16-2, 5.17-2, 5.18-2, 5.19-1,		32	2.059
4	5.2-3, 5.3-3, 5.4-3, 5.5-3, 5.7-3, 5.8-3		6	0.525
5	5.1-1		1	0.446

Спецификация: ось 5

Лист

1:100



6	5.6-1, 5.9-1, 5.10-1		3	1.339
7	5.11-1		1	0.446
Итого:			55	5.425

Спецификация: ось 5

л/см
1:100

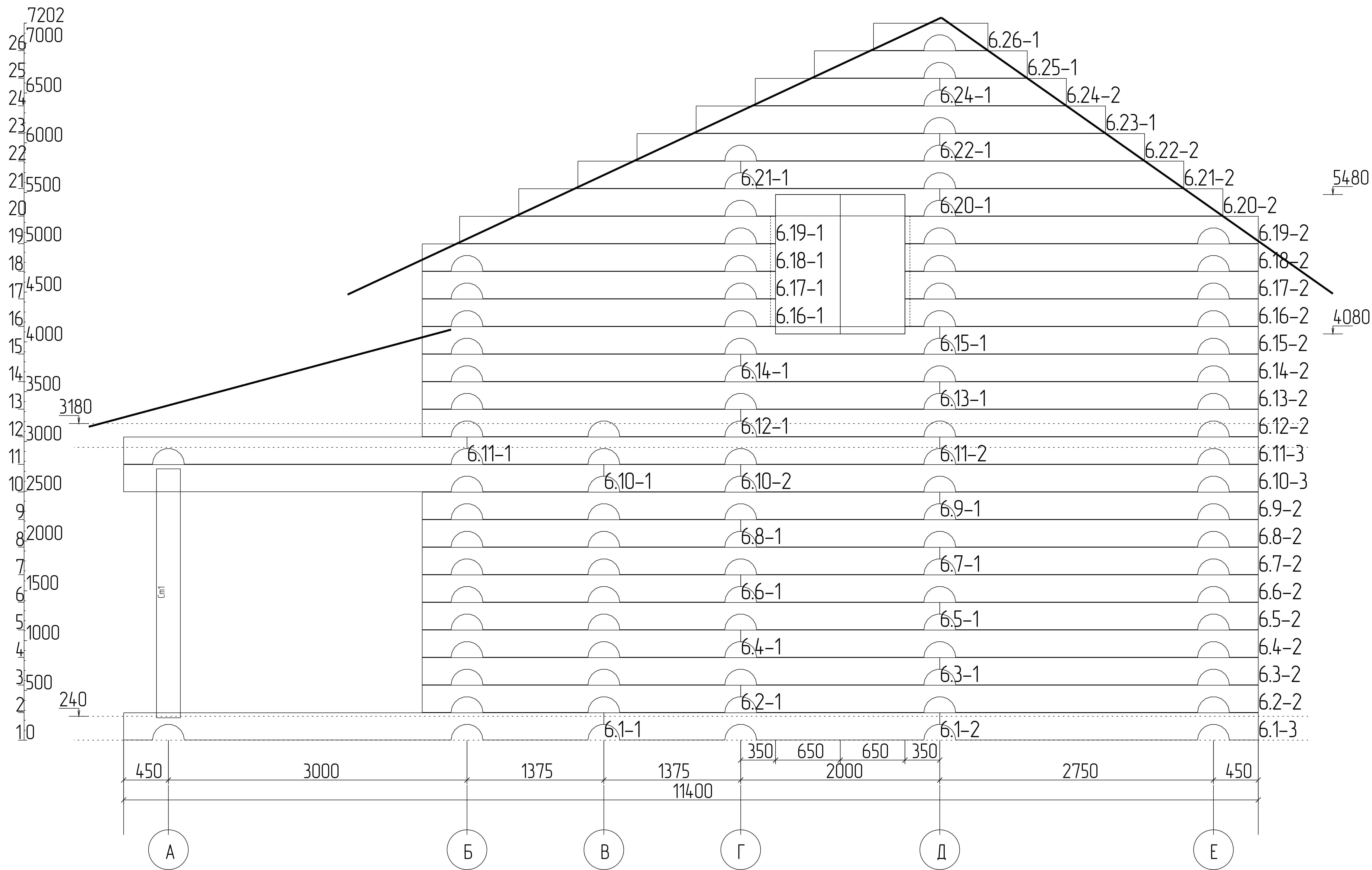

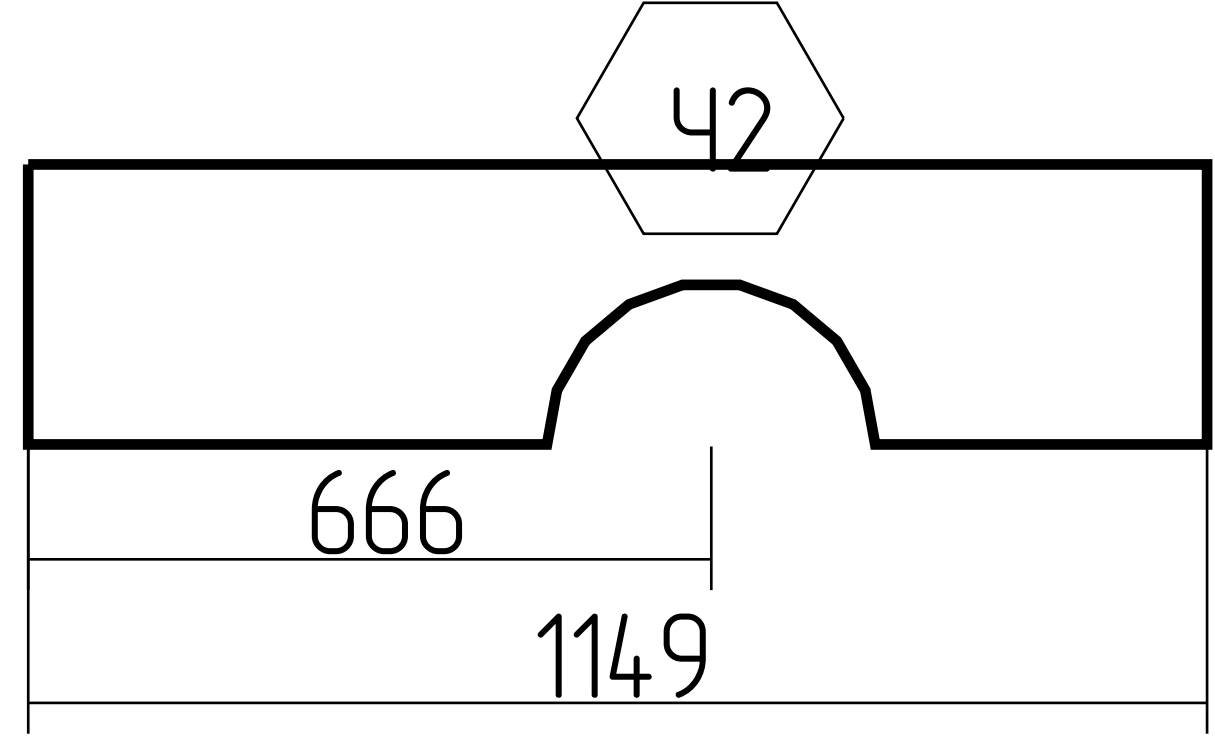
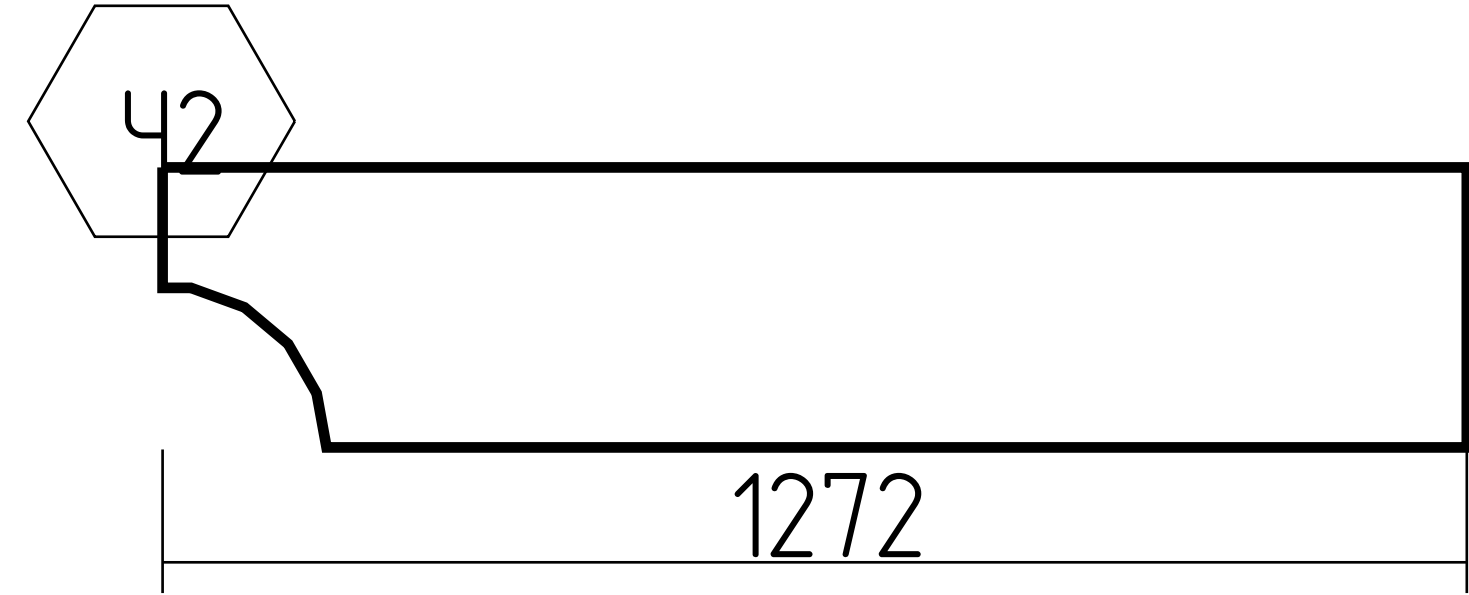
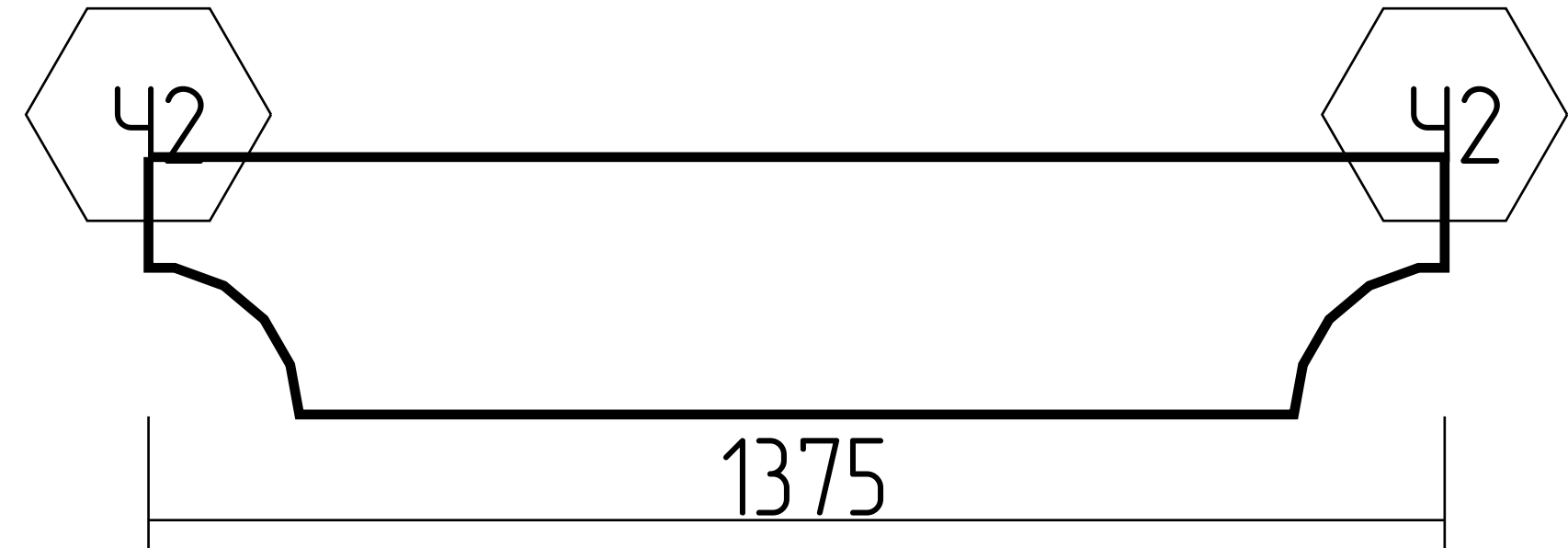
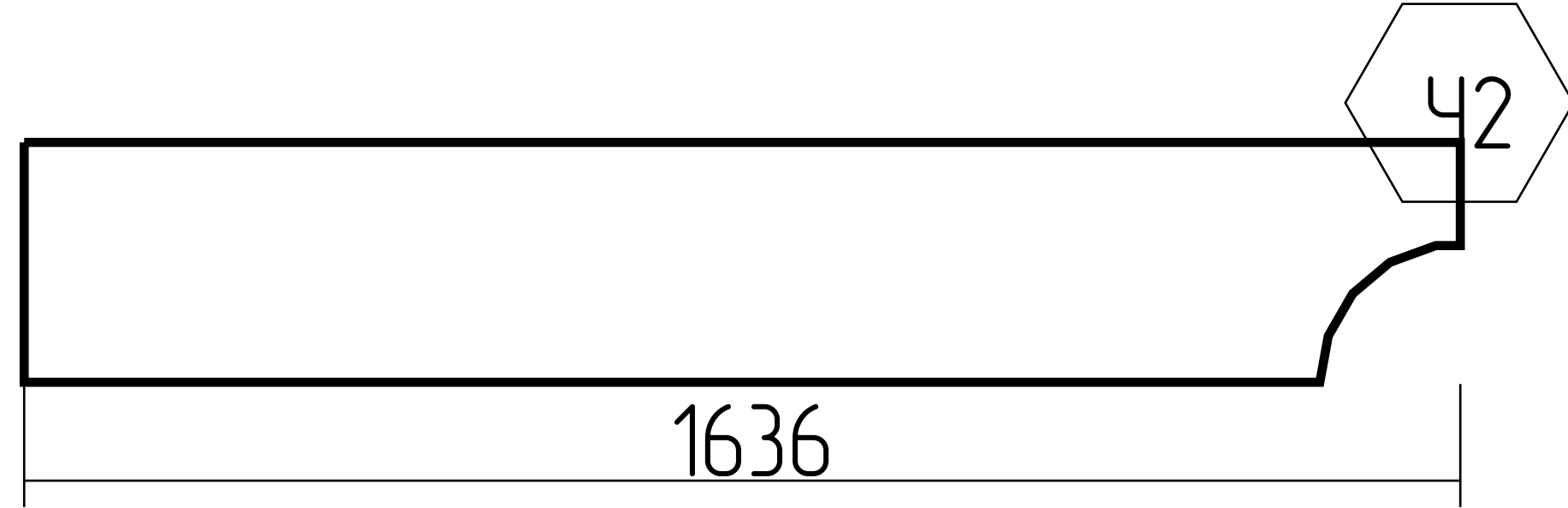
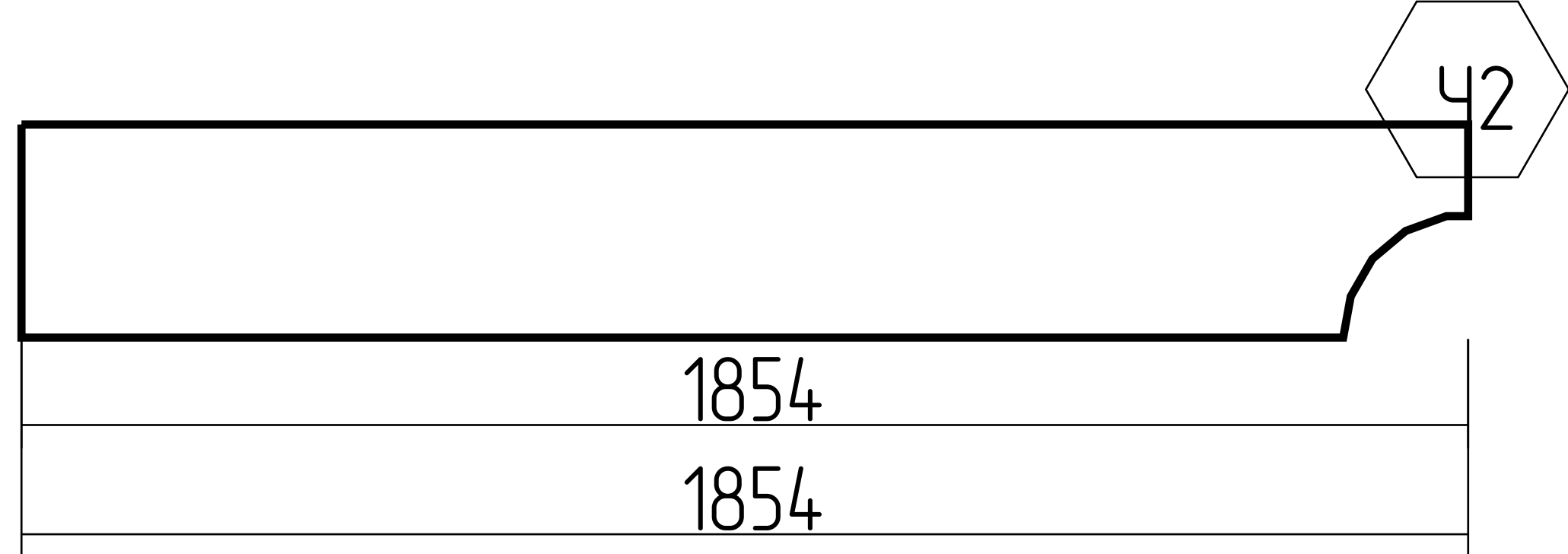
№	Марк.	Эскиз детали	Кол-во (шт)	Объем (м.куд.)
1	6.26-1		1	0.092
2	6.24-2		1	0.102
3	6.10-2		1	0.111
4	6.21-1		1	0.132
5	6.24-1		1	0.149

Спецификация: ось 6

Лист

1:100

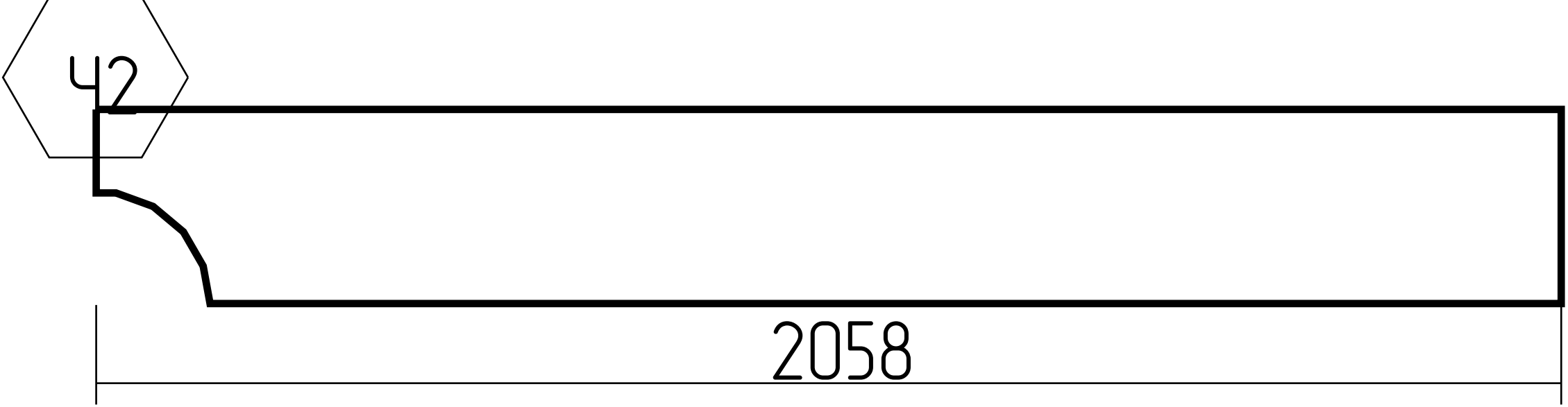
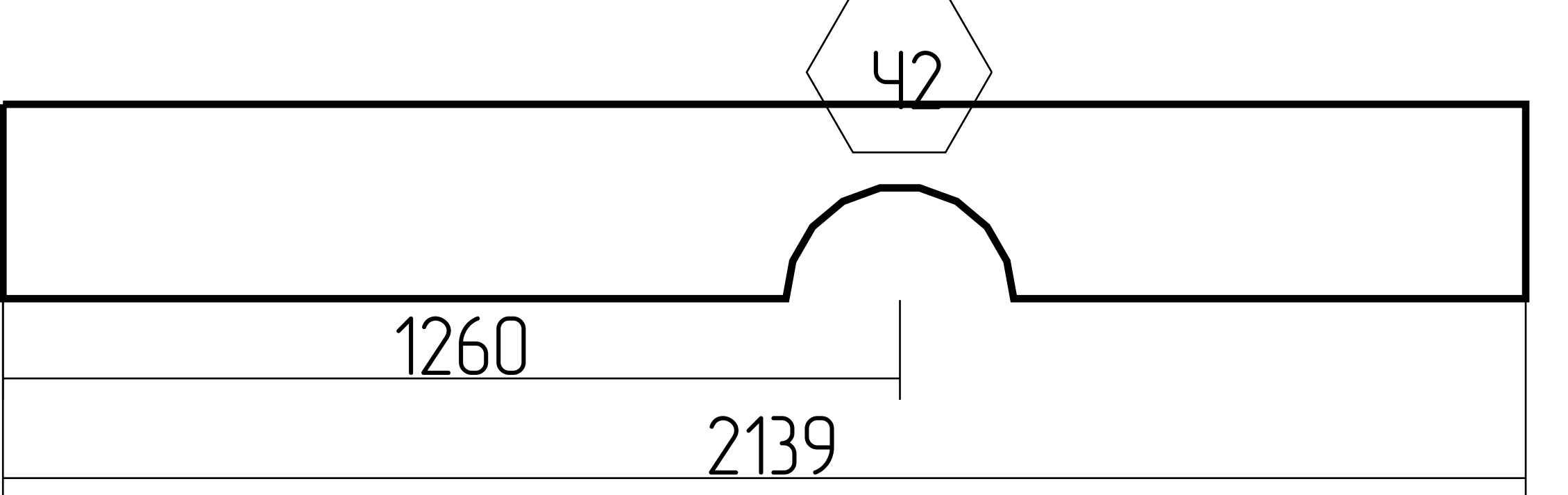
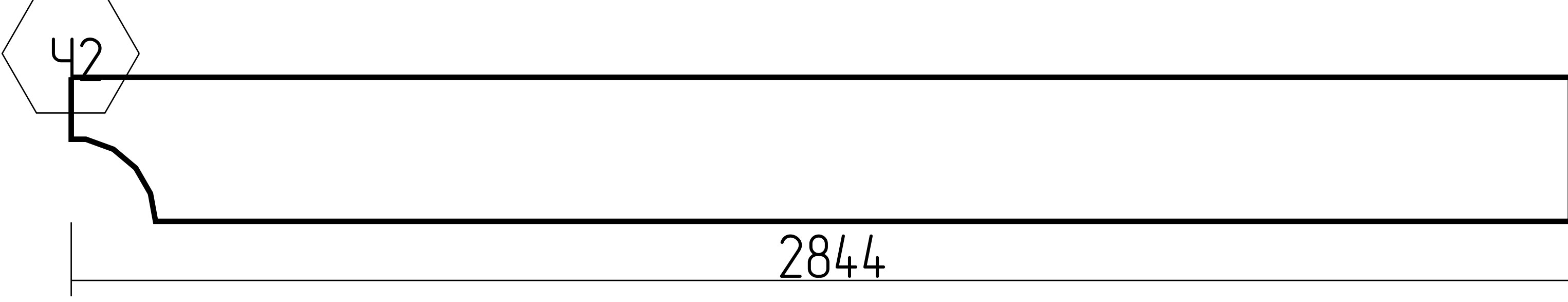
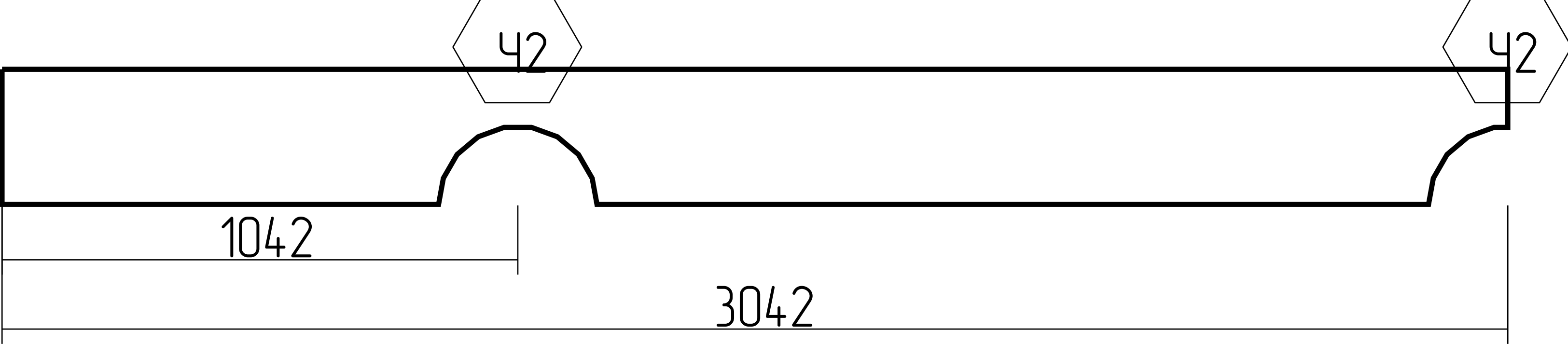
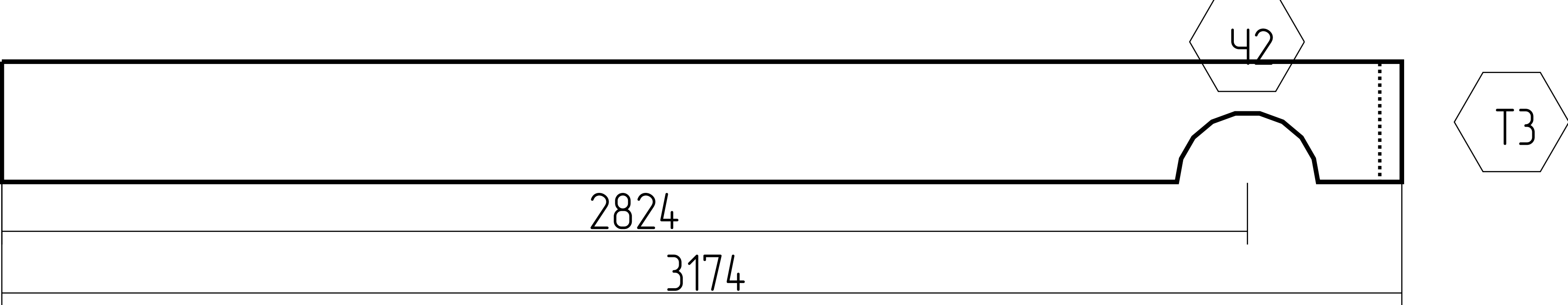
6	6.22-2		1	0.166
7	6.25-1		1	0.172
8	6.20-2		1	0.229
9	6.22-1		1	0.245
10	6.19-1		1	0.255

Спецификация: ось 6

Лист  
1:100

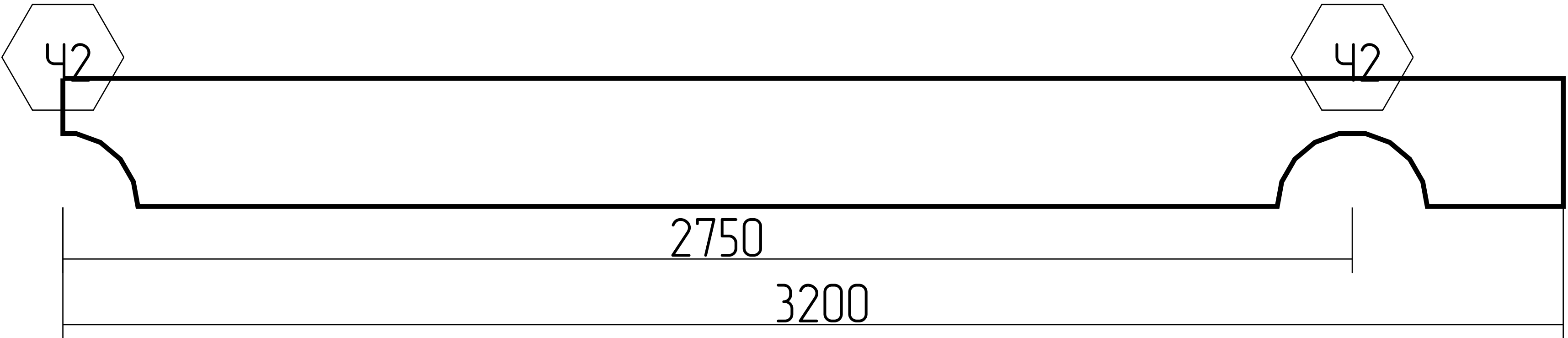
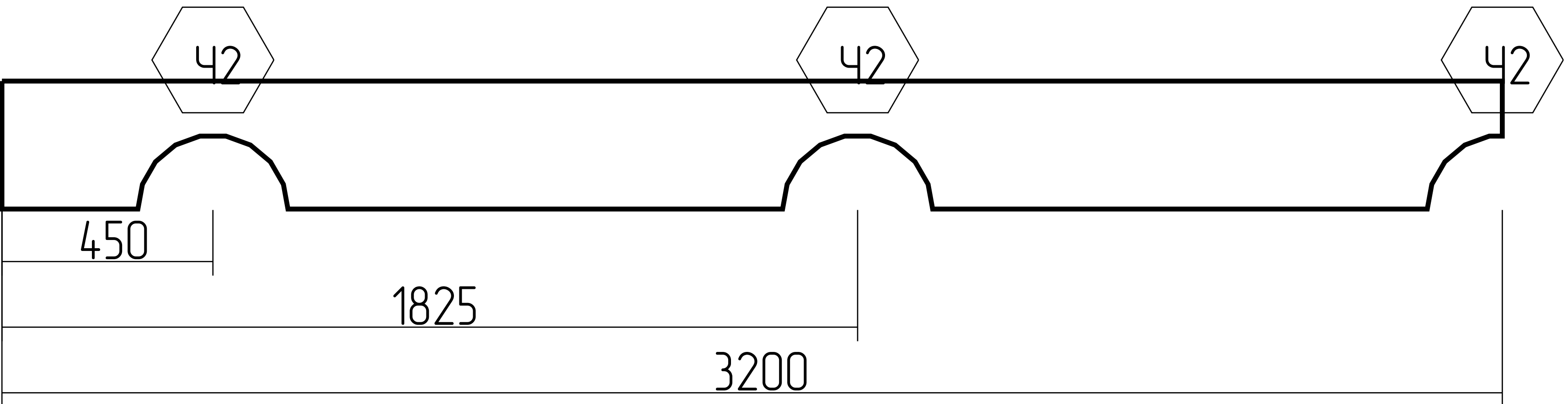
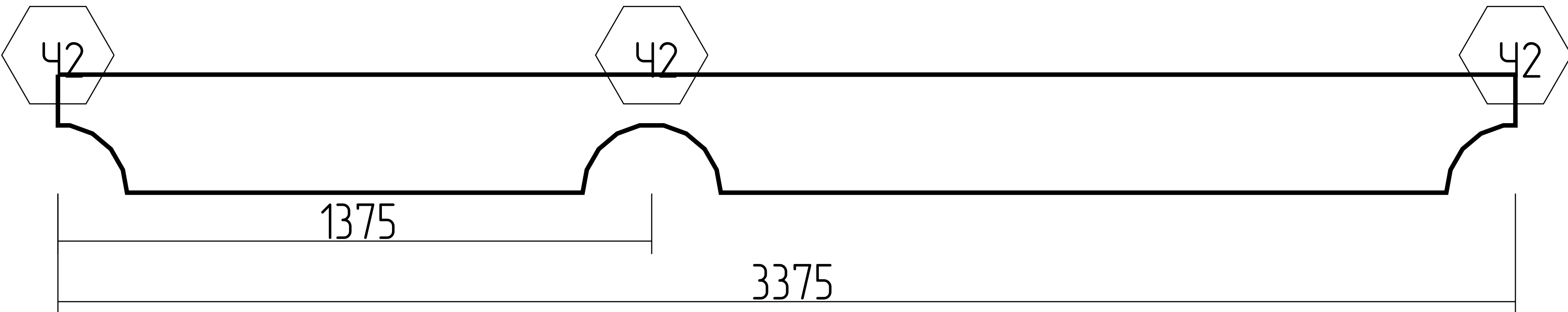
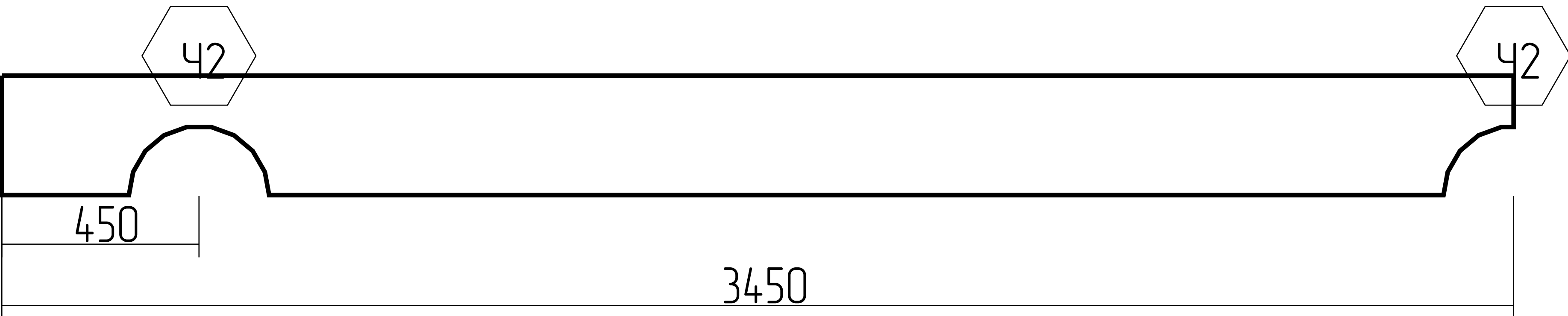
11	6.1-3, 6.3-2, 6.5-2, 6.7-2, 6.9-2, 6.11-3, 6.13-2, 6.14-1, 6.15-2,		9	2.316
12	6.2-1, 6.4-1, 6.6-1, 6.8-1, 6.12-1		5	1.287
13	6.1-2		1	0.271
14	6.11-1		1	0.277

Спецификация: ось 6

Лист

1:100

15	6.16-1, 6.16-2, 6.17-1, 6.17-2, 6.18-1, 6.18-2, 6.19-2,		7	1.999
16	6.23-1		1	0.331
17	6.20-1		1	0.340
18	6.21-2		1	0.358

Спецификация: ось 6

Лист

1:100

19	6.11-2		1	0.382
20	6.1-1		1	0.388
21	6.10-1		1	0.388
22	6.2-2, 6.4-2, 6.6-2, 6.8-2, 6.10-3, 6.12-2, 6.13-1, 6.14-2, 6.15-1,		9	3.764



Спецификация: ось 6

Лист  
1:100

23	6.3-1, 6.5-1, 6.7-1, 6.9-1		4	1.673
			Итого:	52 15.427

				Спецификация: ось 6	Лист
					1:100

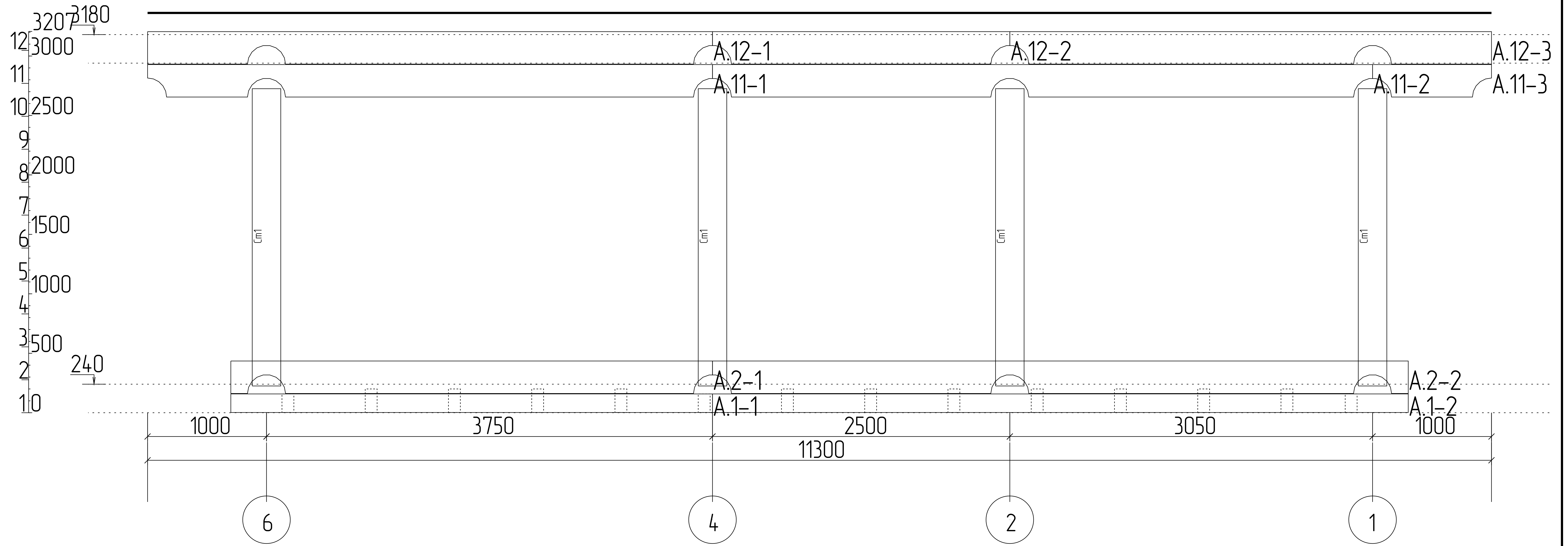





План порядовки: ось А

Лист

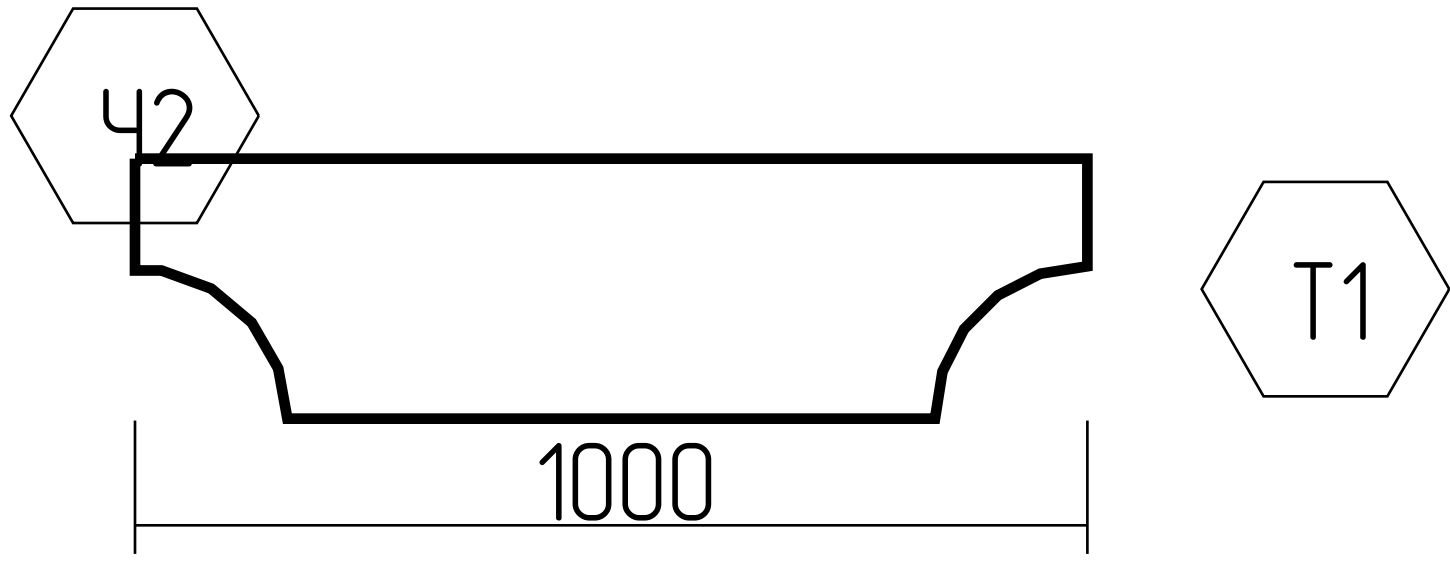
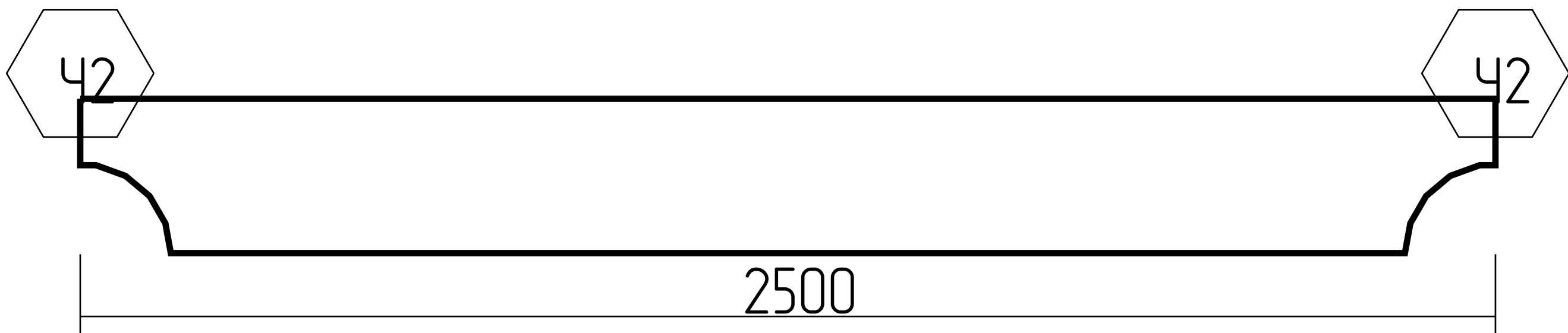
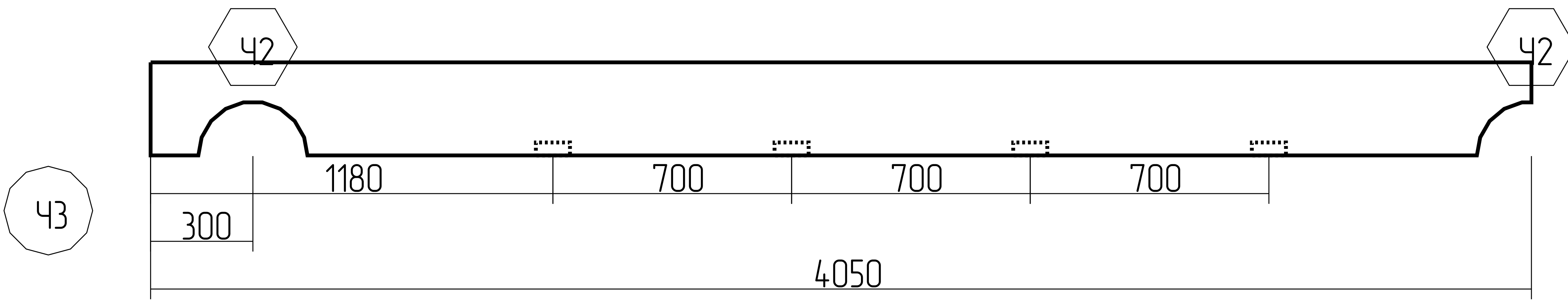
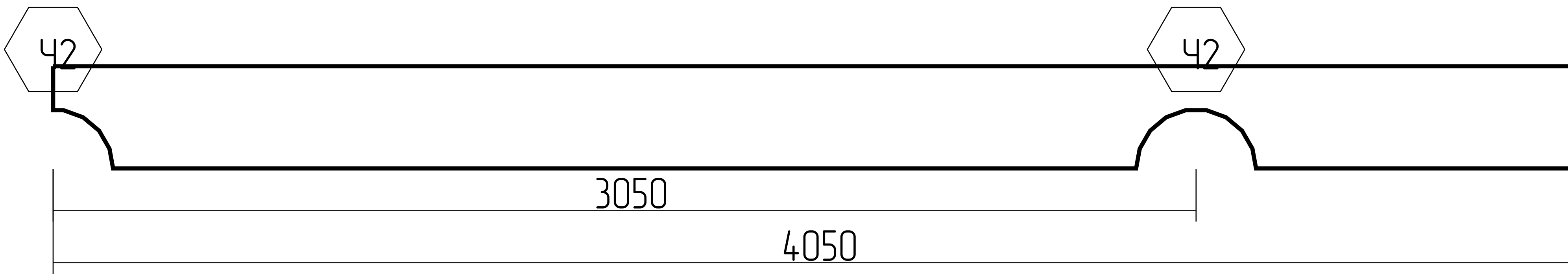
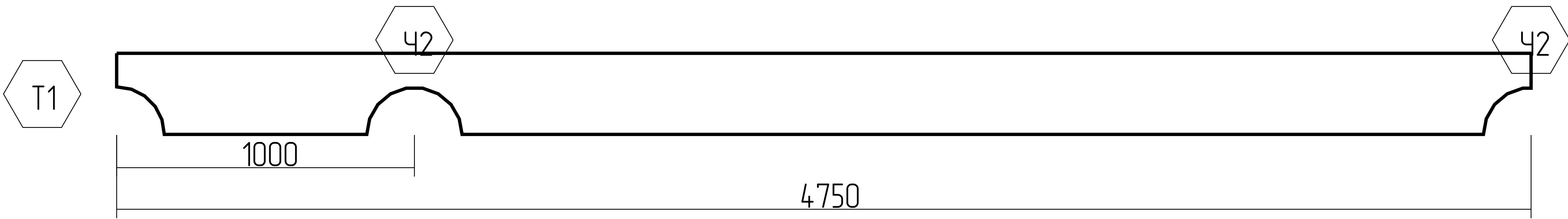
1:46

№	Марк.	Эскиз детали	Кол-во (шт)	Объем (м.куд.)
1	A.11-3		1	0.080
2	A.12-2		1	0.201
3	A.2-1		1	0.326
4	A.12-3		1	0.326
5	A.11-1		1	0.382

Спецификация: ось А

Лист

1:100

6	A.12-1		1	0.382
7	A.11-2		1	0.446
8	A.2-2		1	0.470
9	A.1-1		1	0.163
10	A.1-2		1	0.235
Итого:			10	3.012

Спецификация: ось А

Лист

1:100

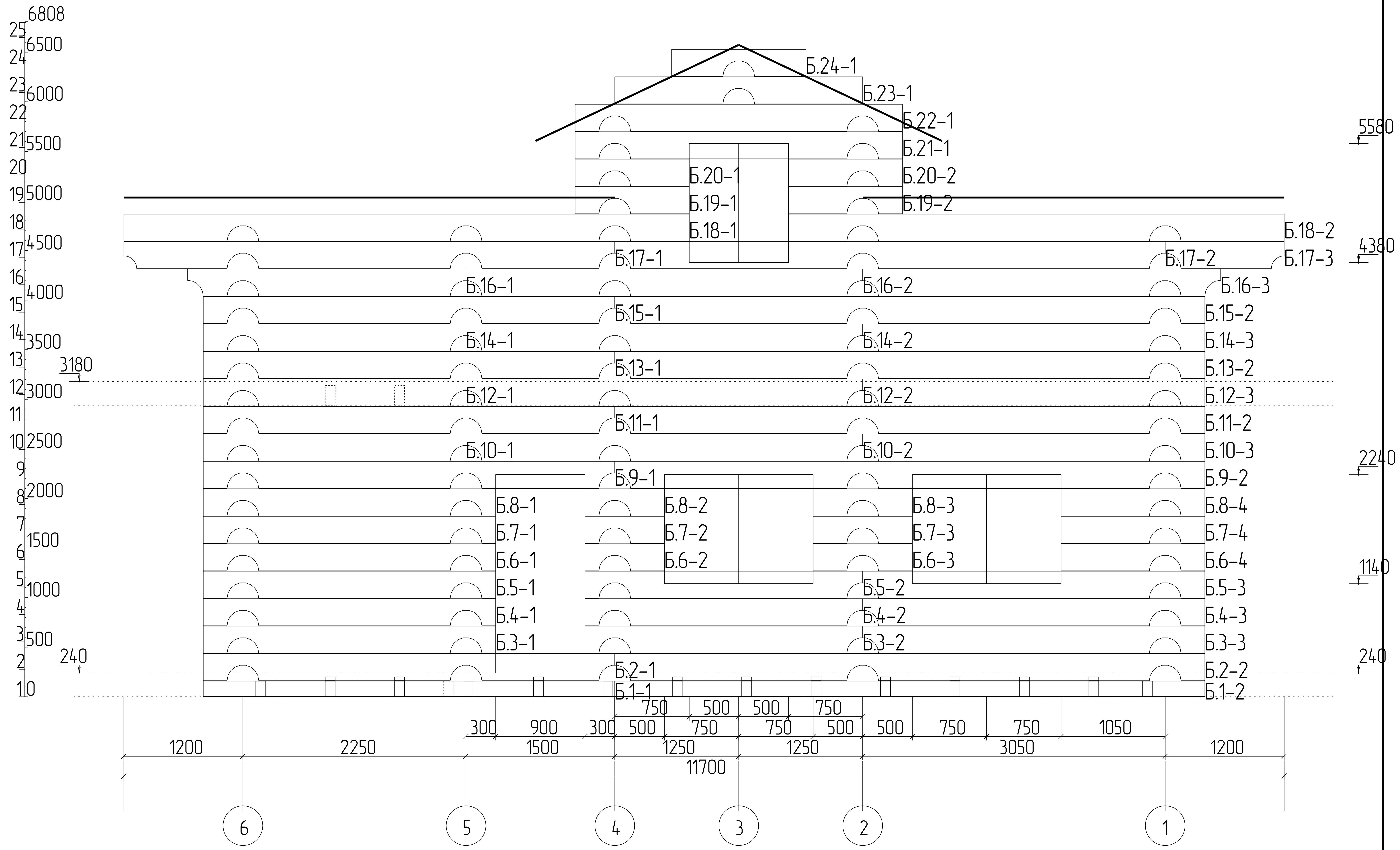

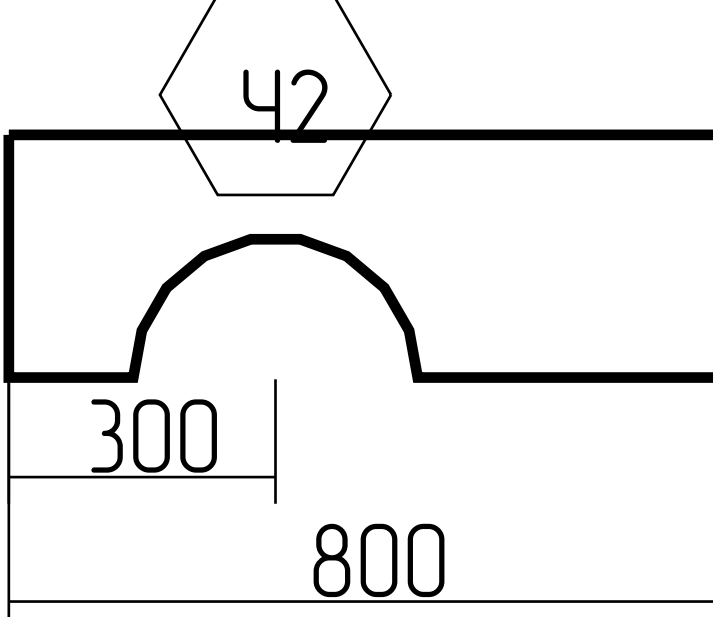
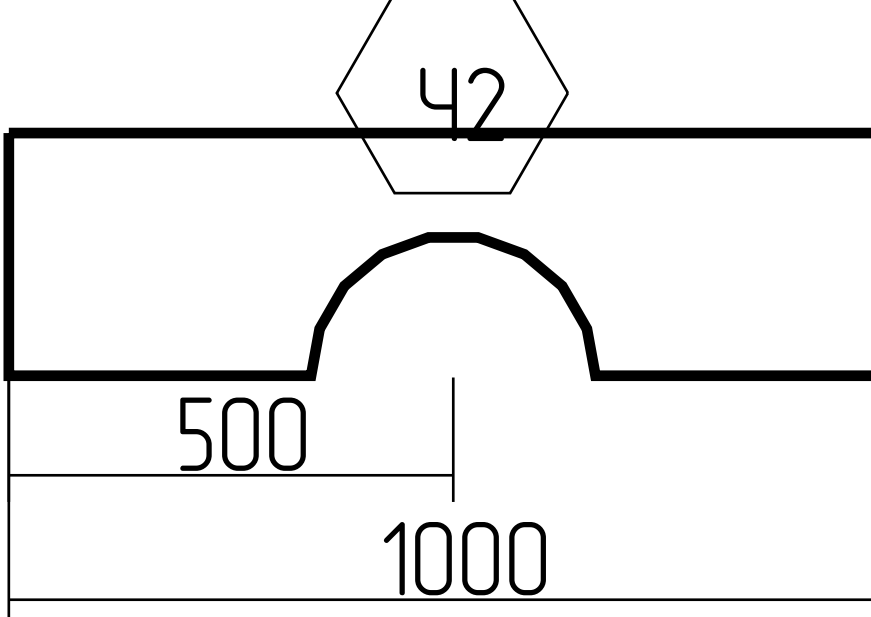
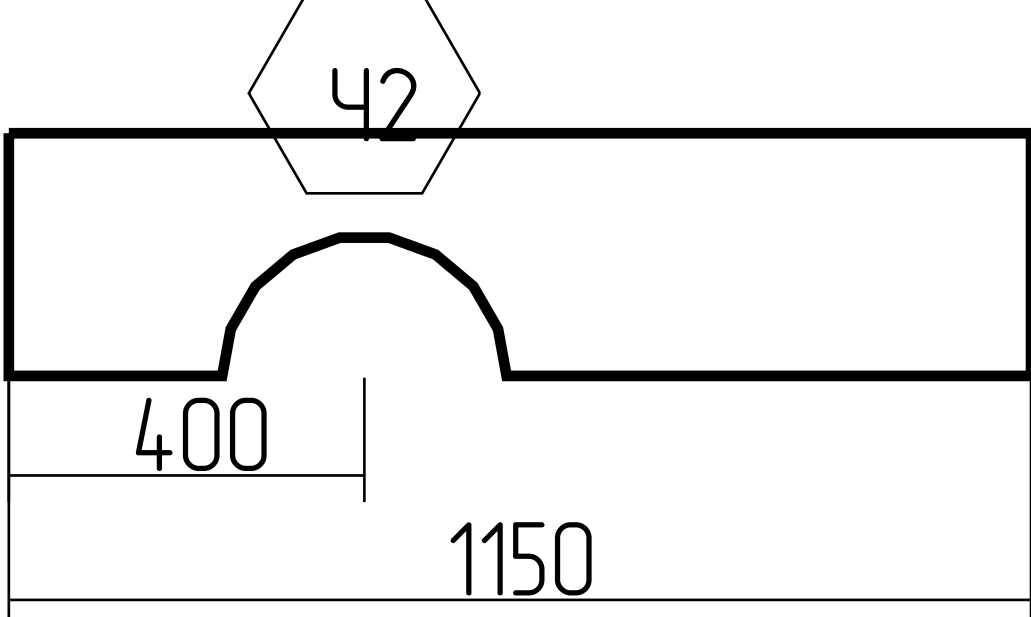
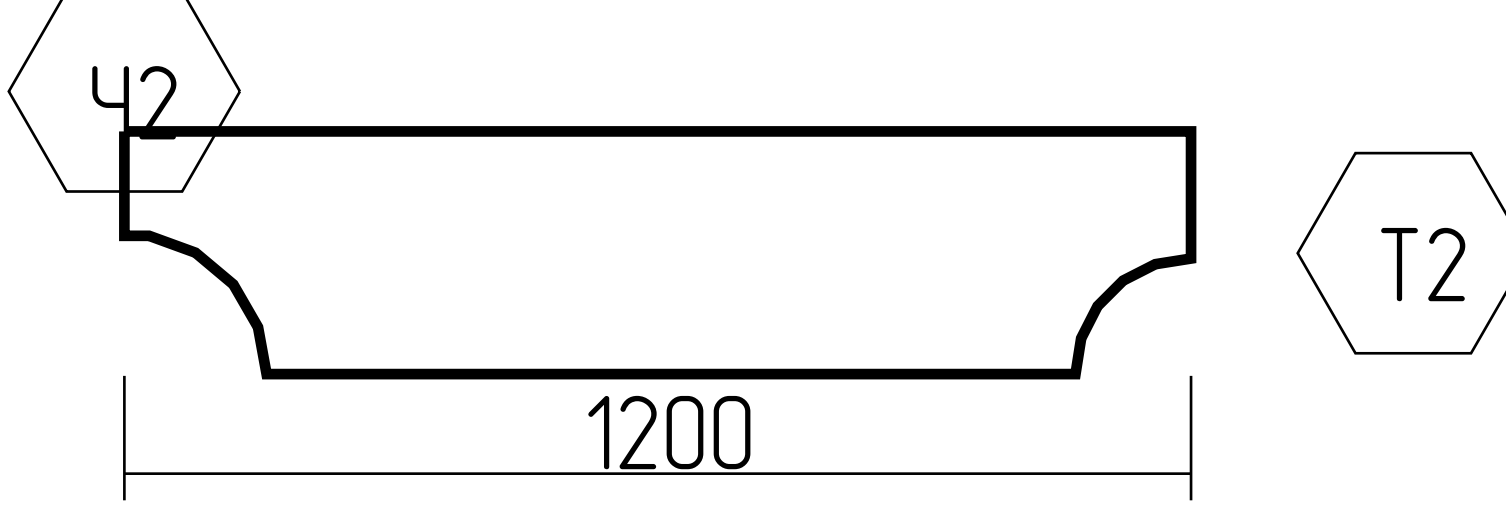
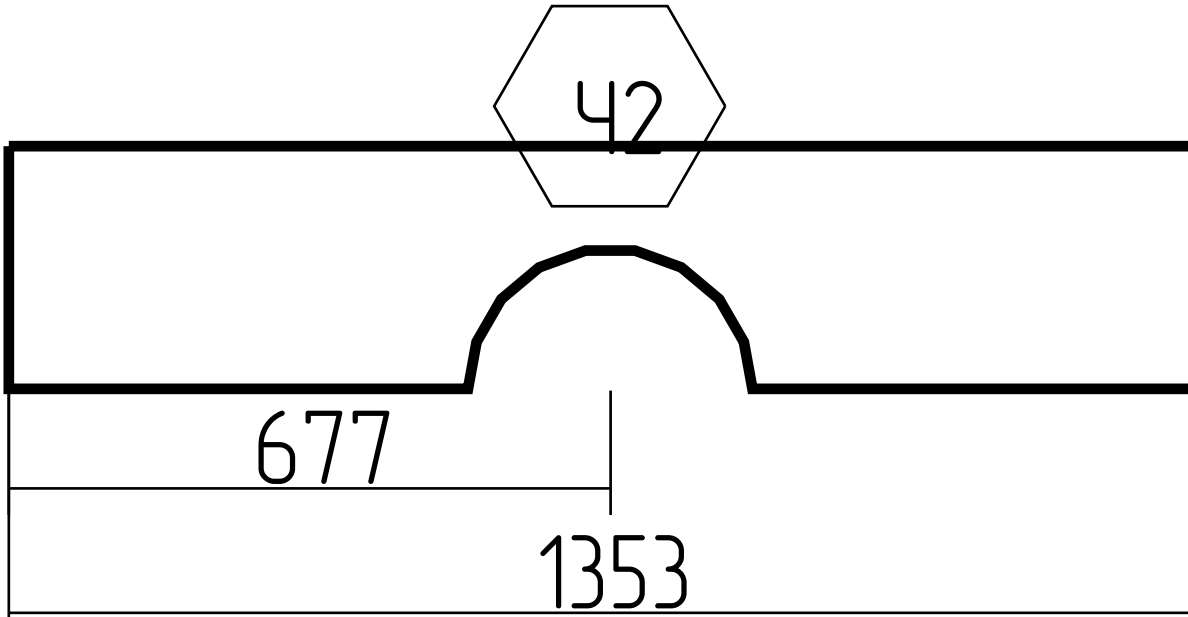
№	Марк.	Эскиз детали	Кол-во (шт)	Объем (м.куд.)
1	Б.6-2, Б.7-2, Б.8-2		3	0.193
2	Б.6-3, Б.7-3, Б.8-3		3	0.241
3	Б.19-1, Б.19-2, Б.20-1, Б.20-2		4	0.370
4	Б.17-3		1	0.097
5	Б.24-1		1	0.109

Спецификация: ось Б

Лист

1:100

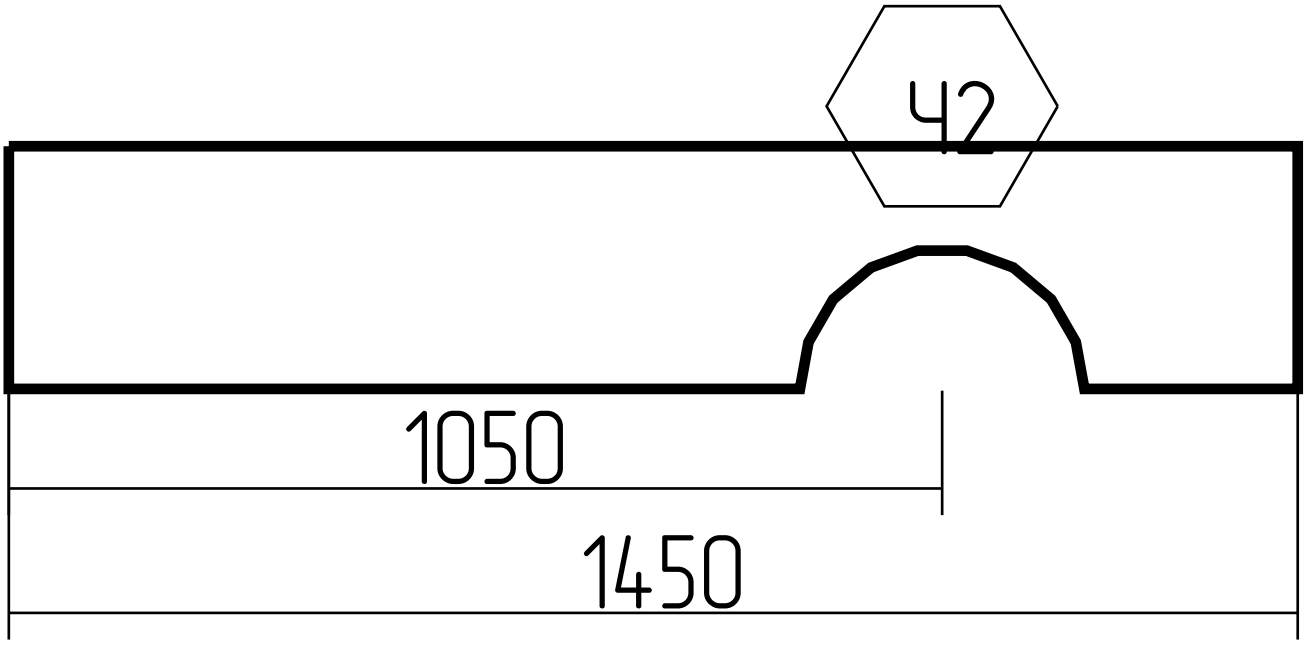
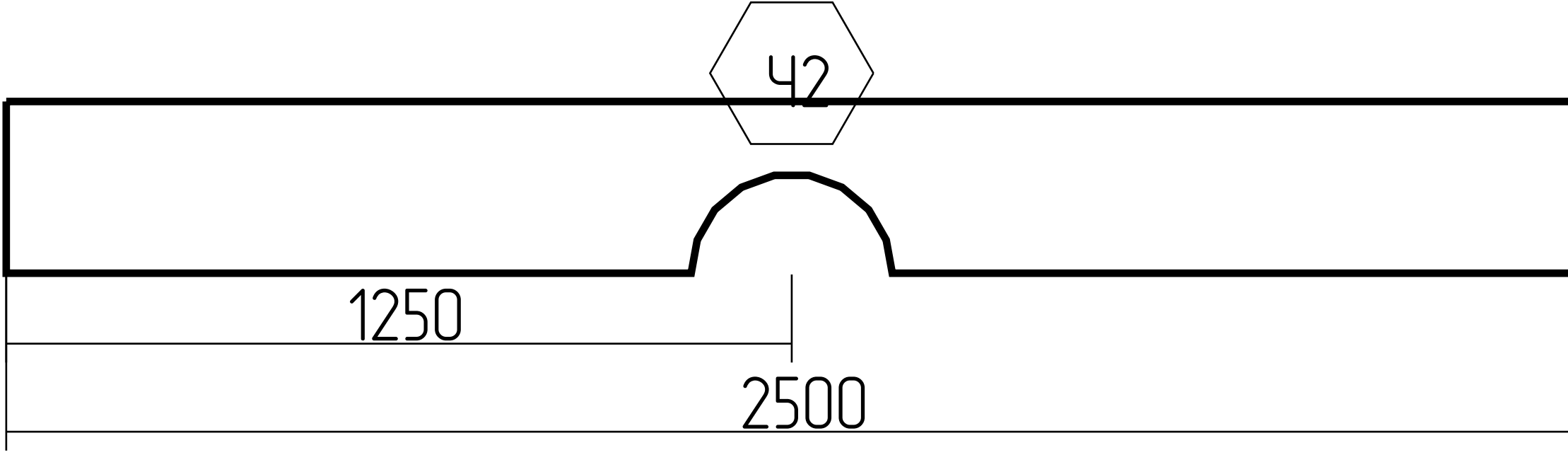
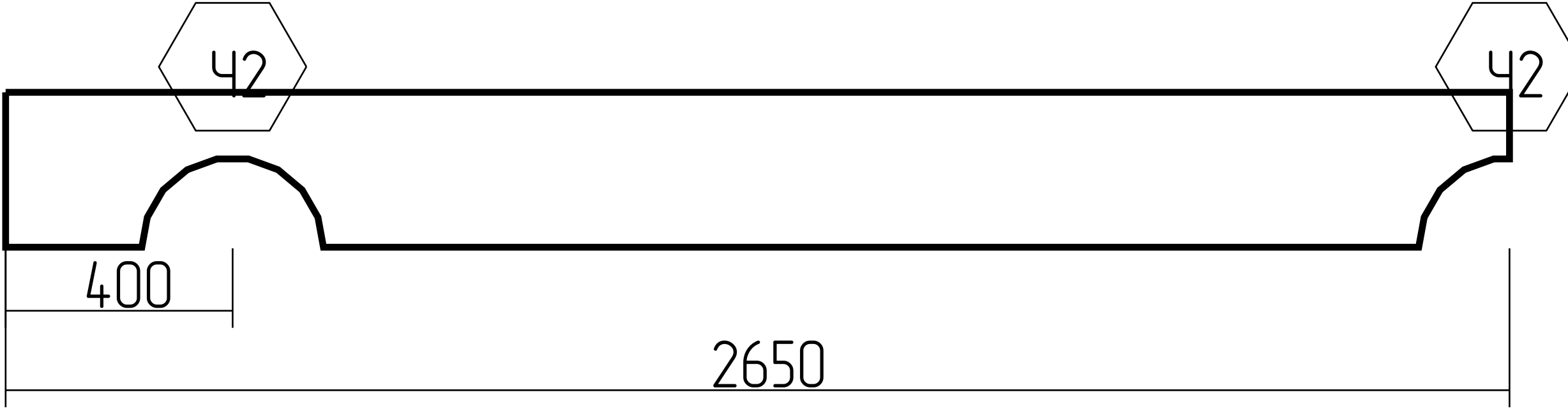
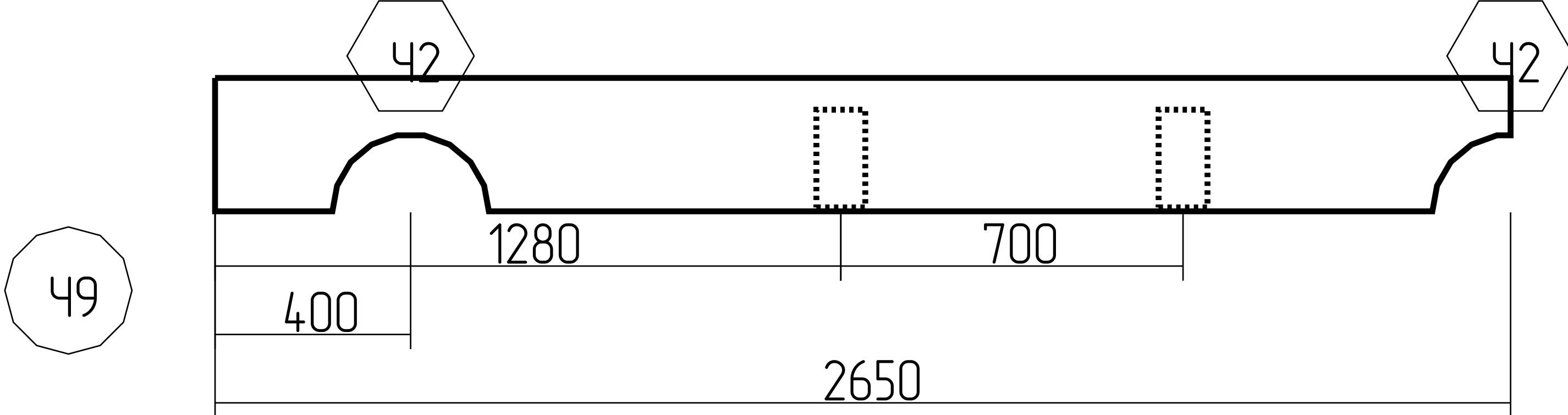
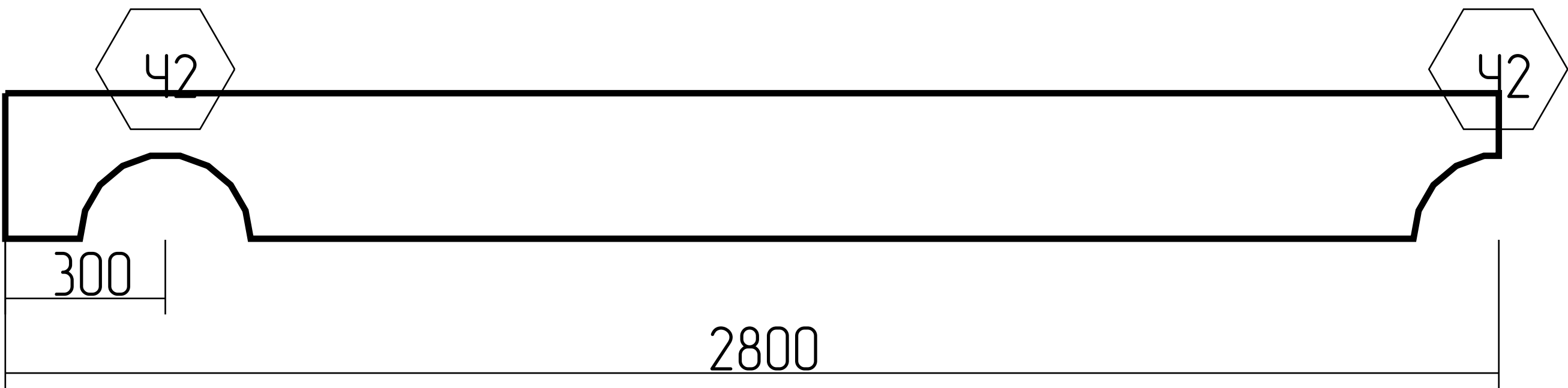
6	Б.6-4, Б.7-4, Б.8-4		3	0.350
7	Б.23-1		1	0.201
8	Б.10-1, Б.14-1		2	0.426
9	Б.12-1		1	0.213
10	Б.3-2, Б.4-2, Б.5-2		3	0.676

Спецификация: ось Б

Лист

1:100

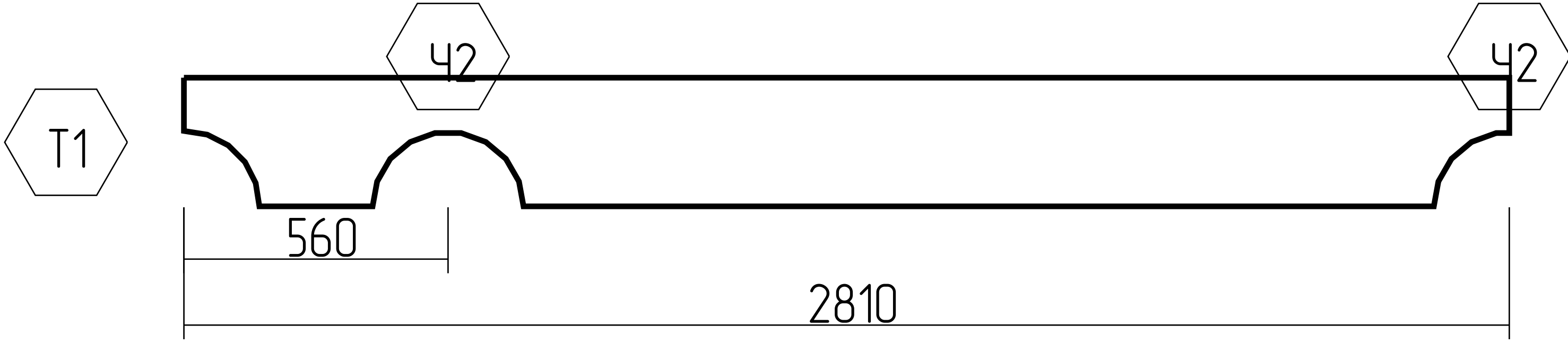
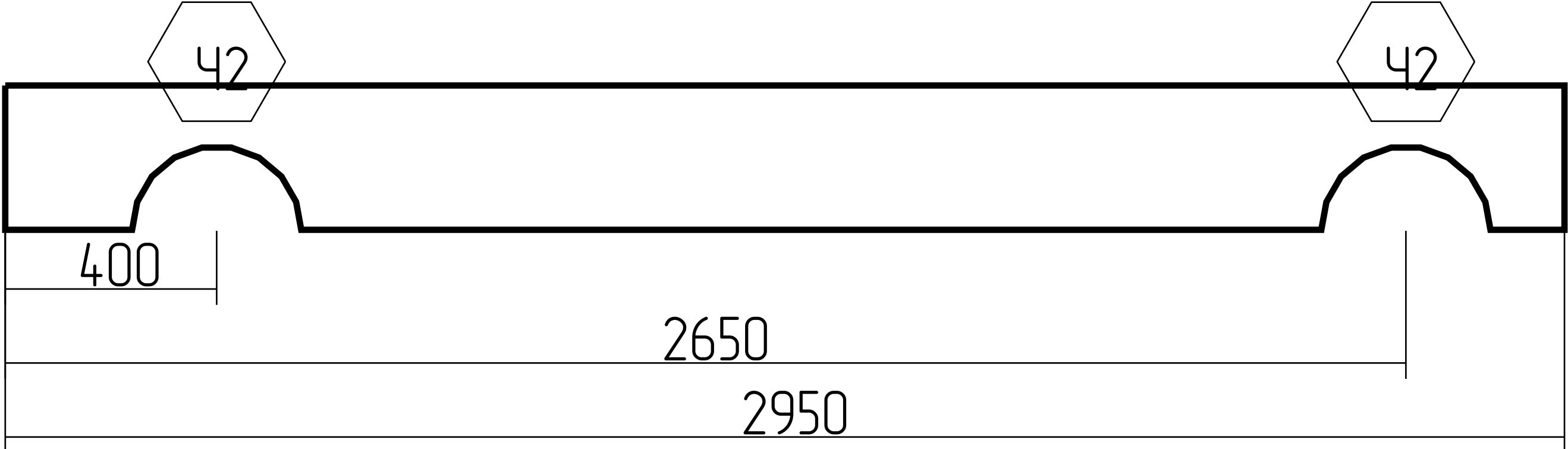
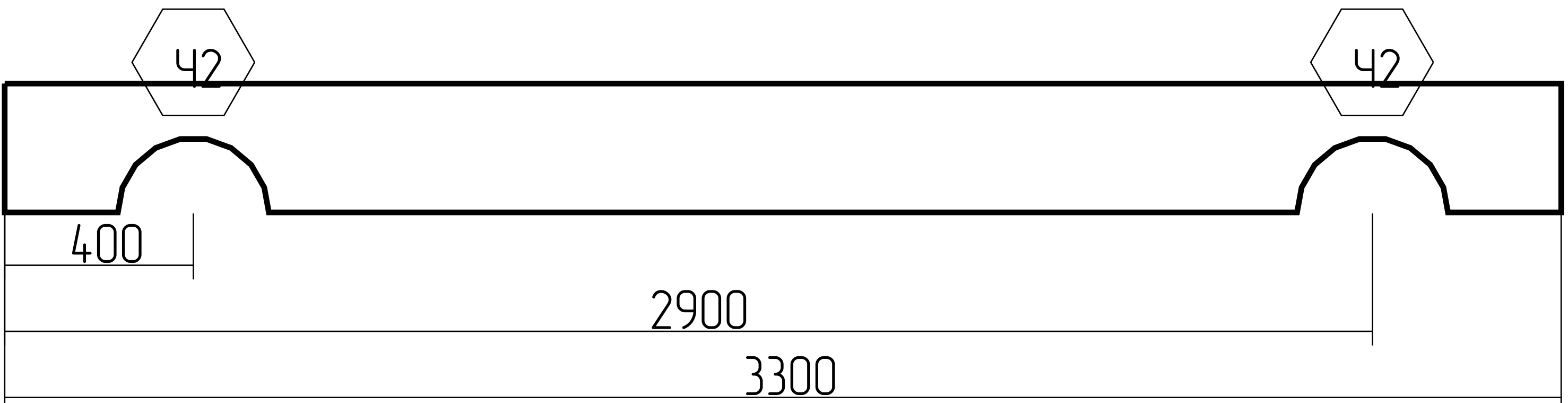
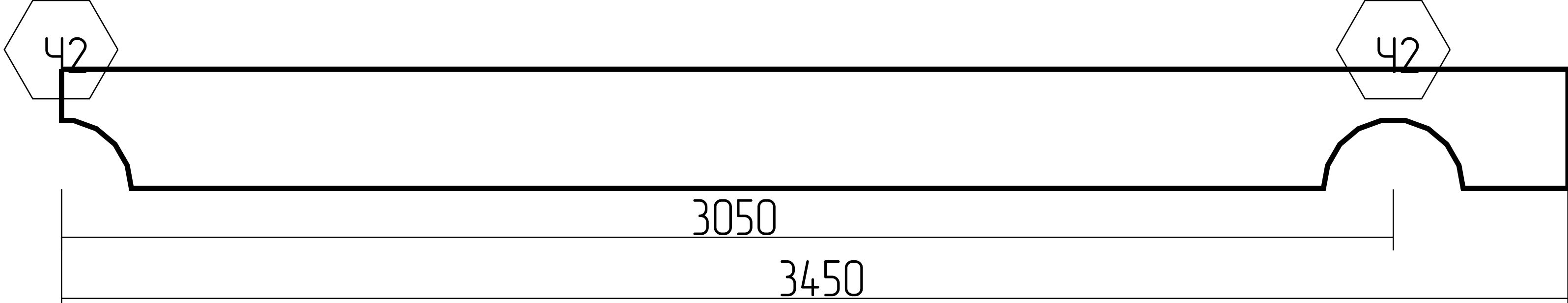
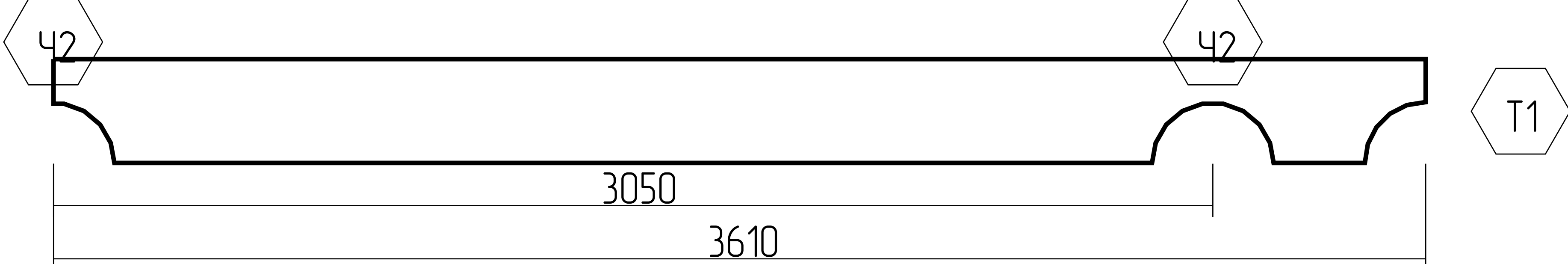
11	Б.16-1		1	0.226
12	Б.3-1, Б.4-1, Б.5-1, Б.6-1, Б.7-1, Б.8-1		6	1.424
13	Б.21-1, Б.22-1		2	0.531
14	Б.3-3, Б.4-3, Б.5-3, Б.10-3, Б.12-3, Б.14-3		6	1.665
15	Б.16-3		1	0.290

Спецификация: ось Б

Лист

1:100

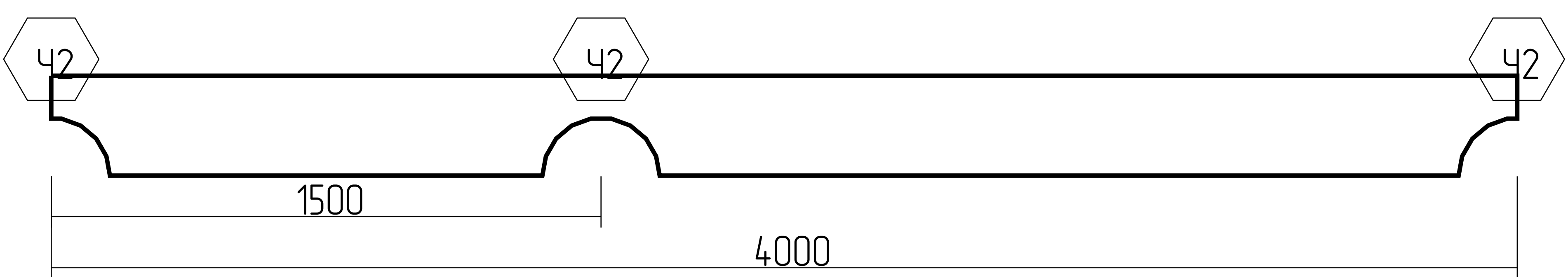
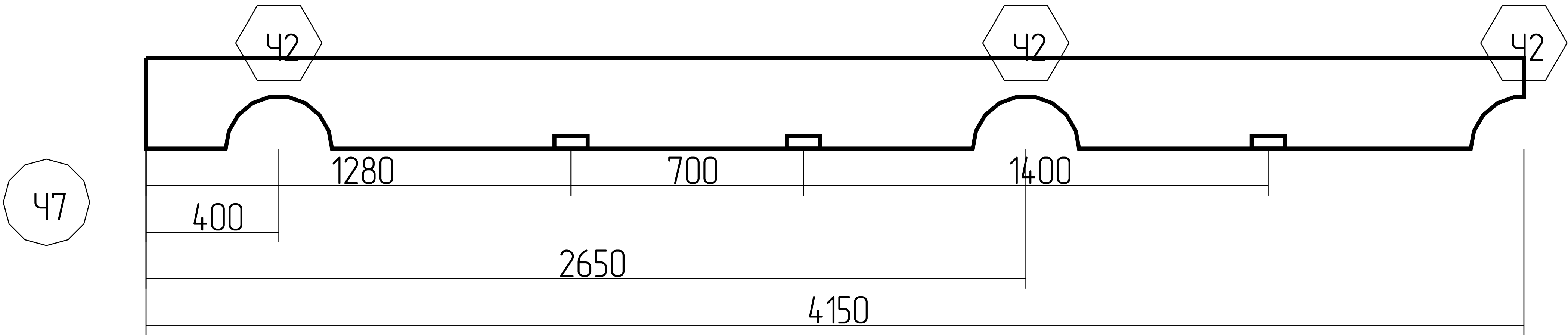
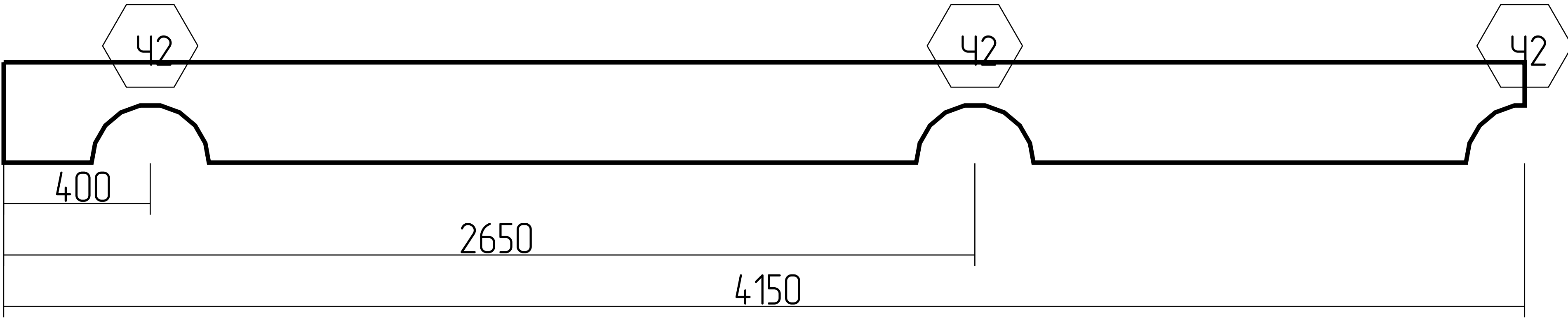
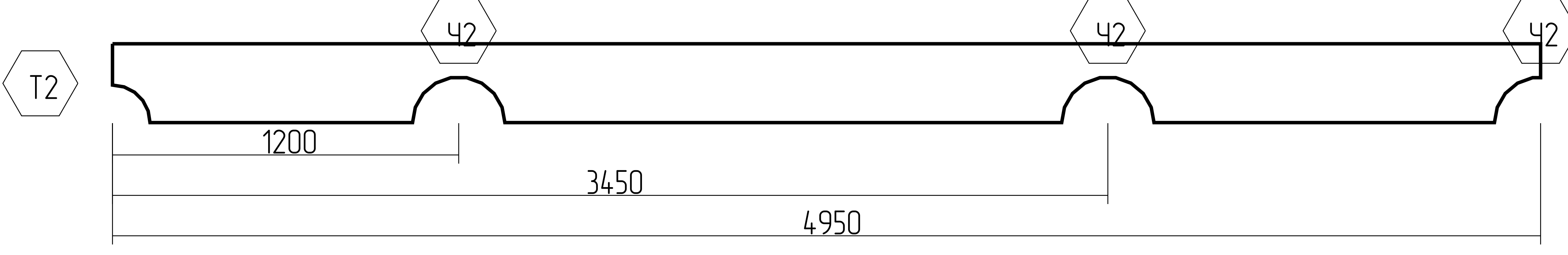
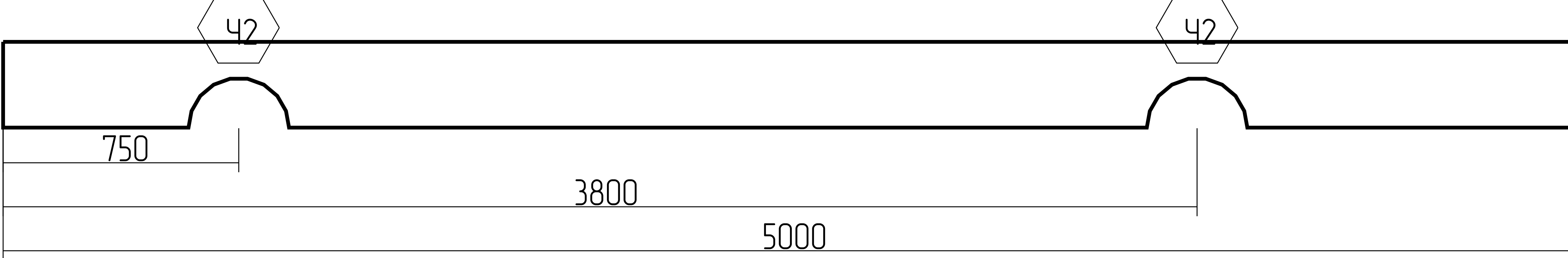
16	Б.10-2, Б.12-2, Б.14-2, Б.16-2		4	1.287
17	Б.2-1		1	0.334
18	Б.9-1, Б.11-1, Б.13-1, Б.15-1		4	1.335
19	Б.17-1		1	0.398
20	Б.18-2		1	0.402

Спецификация: ось Б

Лист

1:100



21	Б.17-2		1	0.446
22	Б.18-1		1	0.458
23	Б.2-2		1	0.479
24	Б.9-2, Б.11-2, Б.13-2, Б.15-2		4	1.914
25	Б.1-1		1	0.167



Спецификация: ось Б

Лист

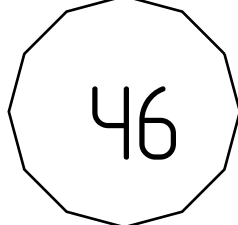
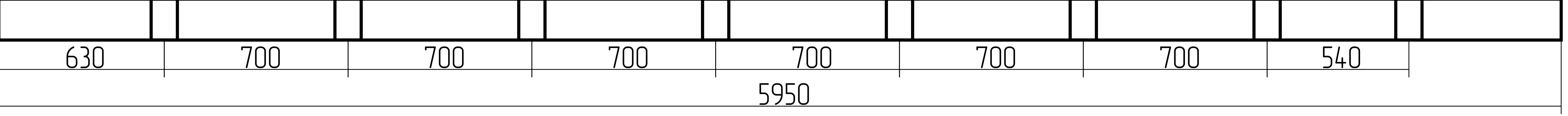
1:100

26	Б.1-2			1	0.239
				Итого:	58 14.470

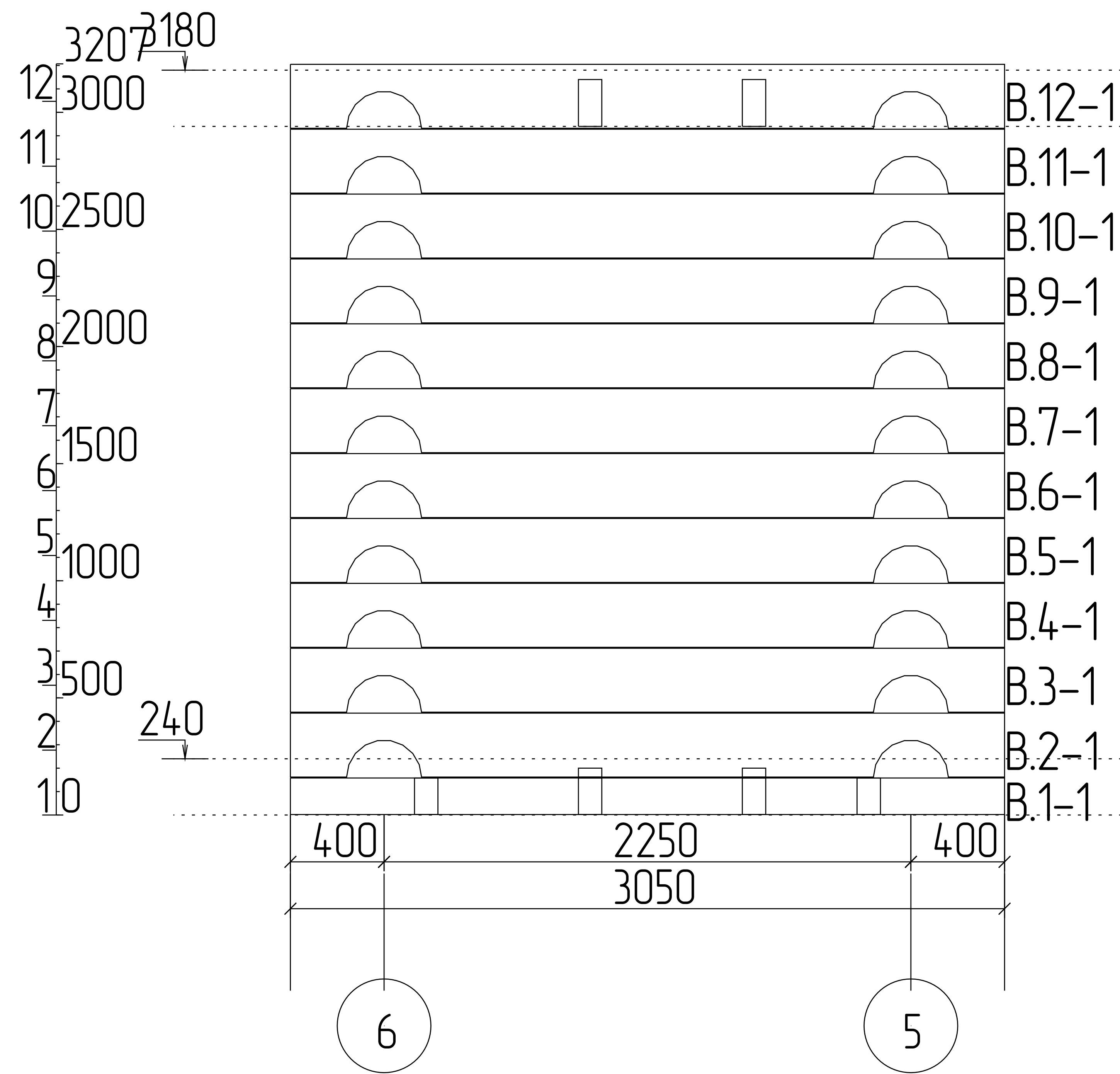
				Спецификация: ось Б	Лист
					1:100



План порядовки: ось В

Лист

1:44

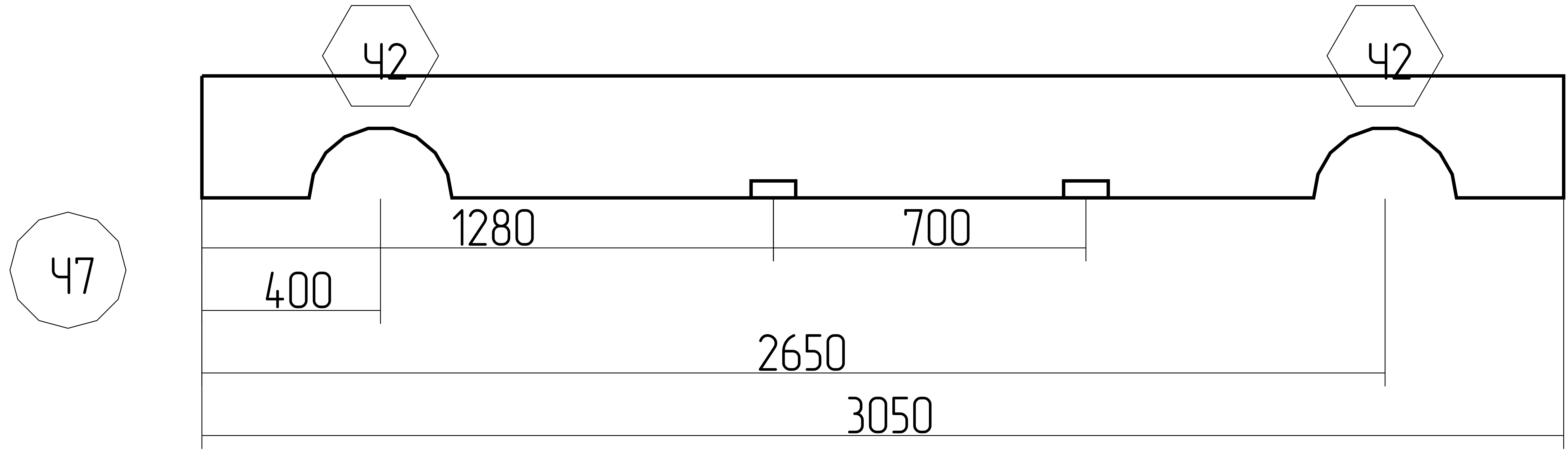
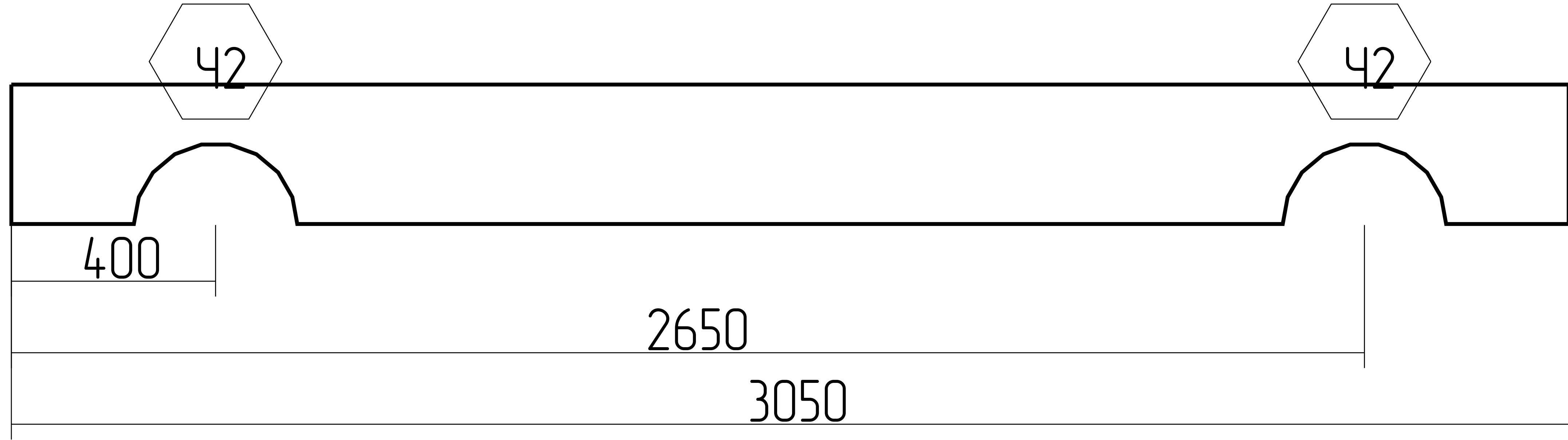
№	Марк.	Эскиз детали	Кол-во (шт)	Объем (м.куб.)
1	В.2-1		1	0.245
2	В.3-1, В.4-1, В.5-1, В.6-1, В.7-1, В.8-1, В.9-1, В.10-1, В.11-1,		9	2.208

Спецификация: ось В

Лист

1:100

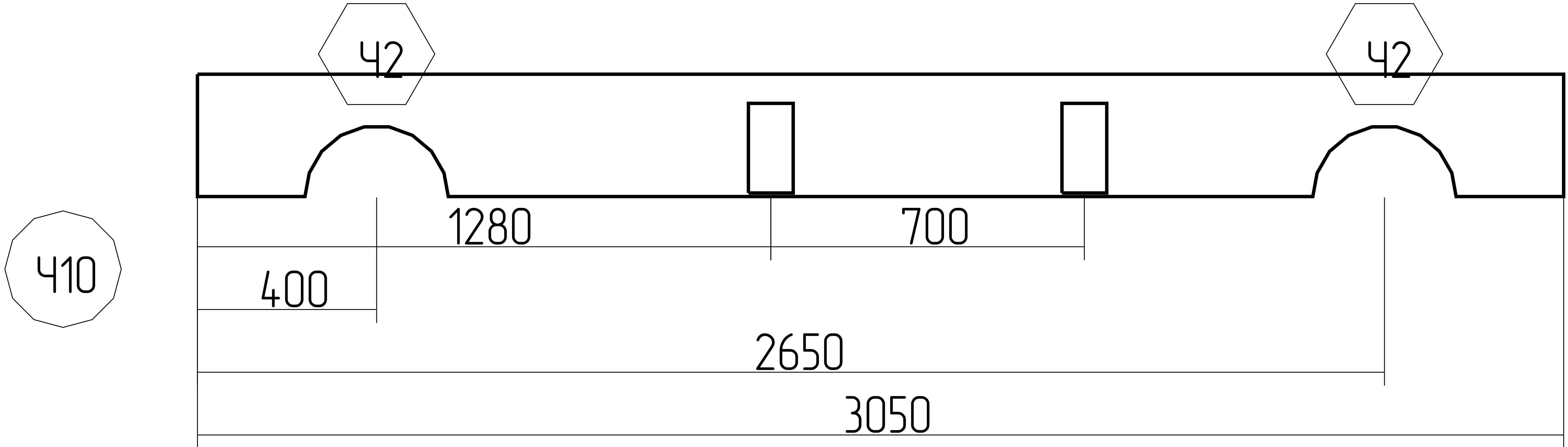
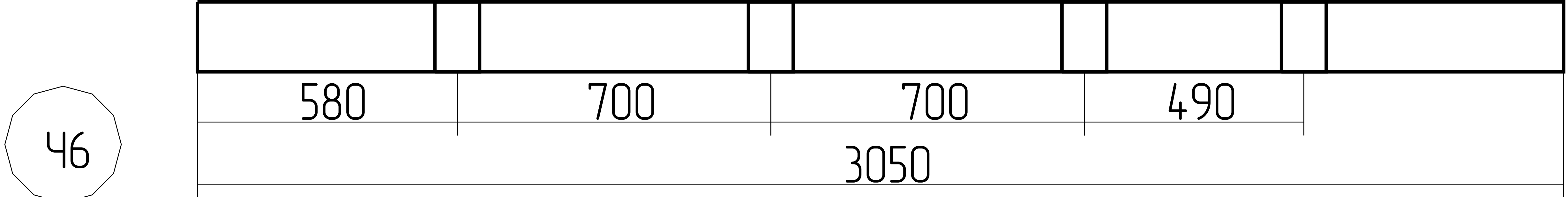
3	B.12-1		1	0.245
4	B.1-1		1	0.123
Итого:			12	2.821

Спецификация: ось В

Лист

1:100

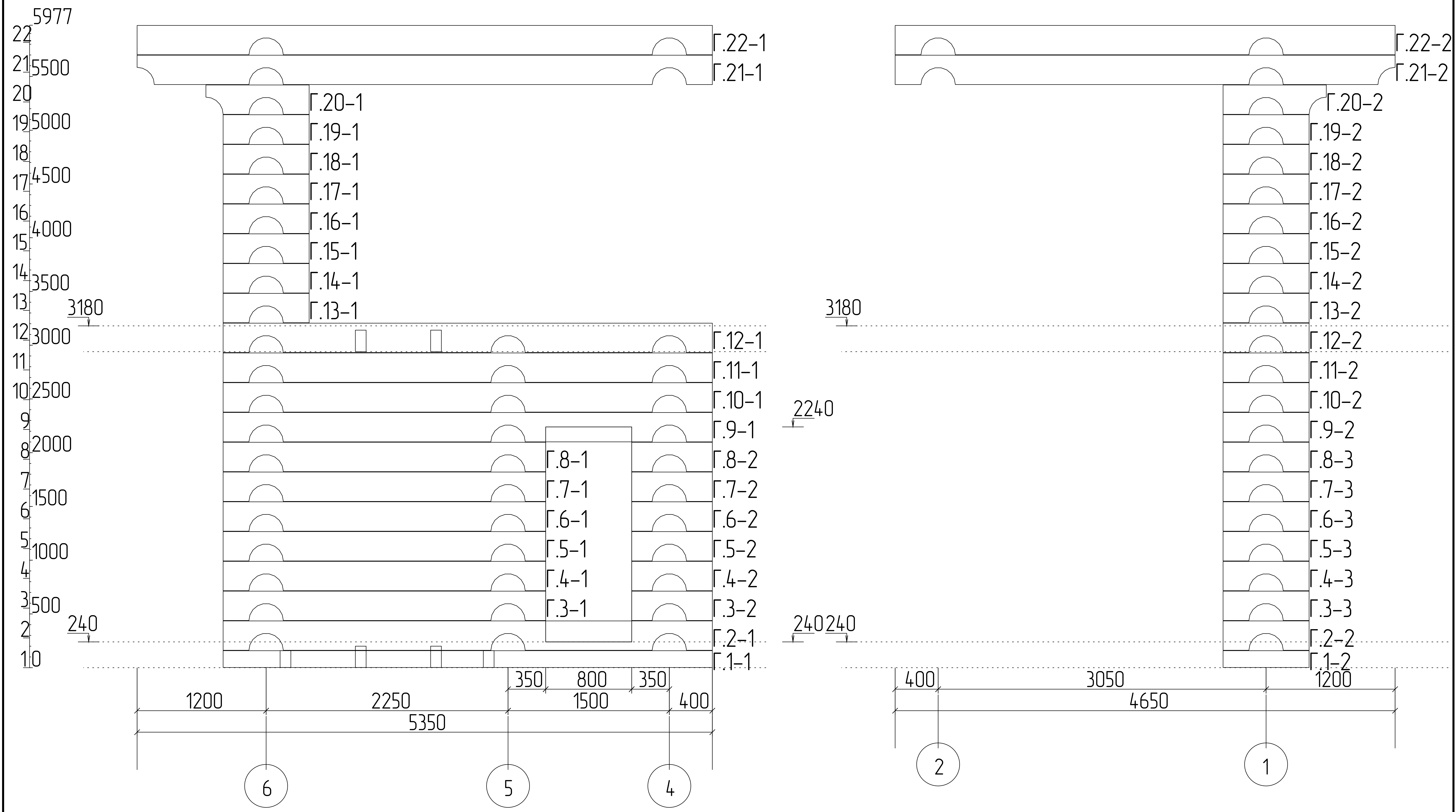

					План порядовки: ось Г	л/см
						1:47

№	Марк.	Эскиз детали	Кол-во (шт)	Объем (м.куб.)
1	Г.3-2, Г.4-2, Г.5-2, Г.6-2, Г.7-2, Г.8-2		6	0.362
2	Г.13-1, Г.14-1, Г.15-1, Г.16-1, Г.17-1, Г.18-1, Г.19-1, Г.2-2, Г.3-3, Г.4-3, Г.5-3, Г.6-3, Г.7-3, Г.8-3, Г.9-2, Г.10-2, Г.11-2, Г.12-2, Г.13-2, Г.14-2, Г.15-2, Г.16-2, Г.17-2, Г.18-2, Г.19-2		25	1.608
3	Г.20-1, Г.20-2		2	0.154
4	Г.3-1, Г.4-1, Г.5-1, Г.6-1, Г.7-1, Г.8-1		6	1.448
5	Г.2-1		1	0.366

Спецификация: ось Г

Лист

1:100

6	Г.9-1, Г.10-1, Г.11-1		3	1.098
7	Г.12-1		1	0.366
8	Г.21-2		1	0.374
9	Г.22-2		1	0.374
10	Г.21-1		1	0.430



Спецификация: ось Г

Лист  
1:100

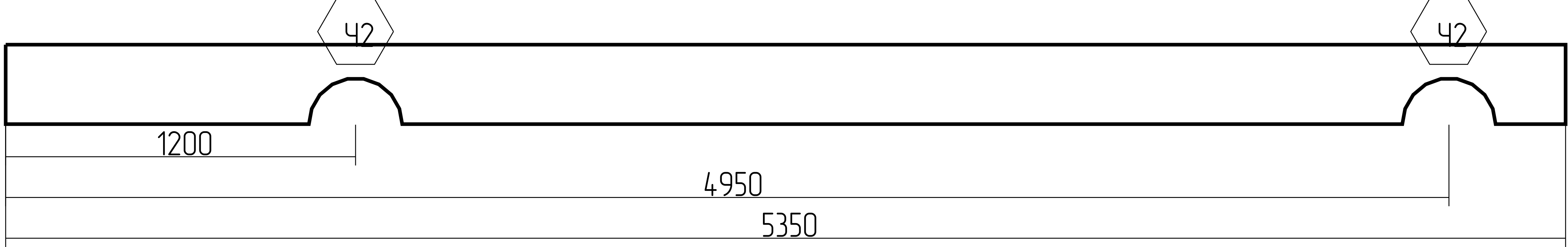
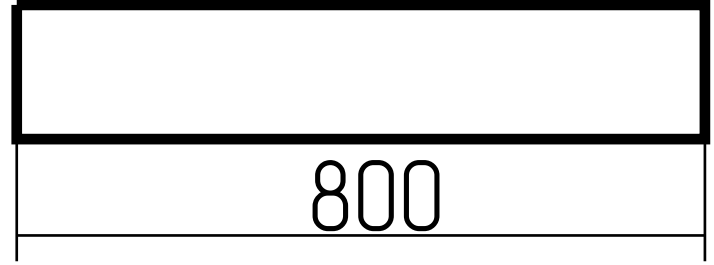
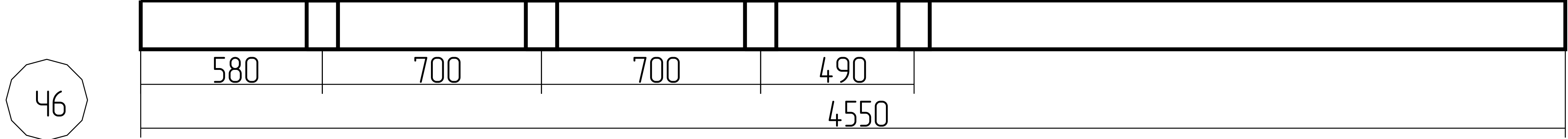

11	Г.22-1		1	0.430
12	Г.1-2		1	0.032
13	Г.1-1		1	0.183
Итого:			50	7.226

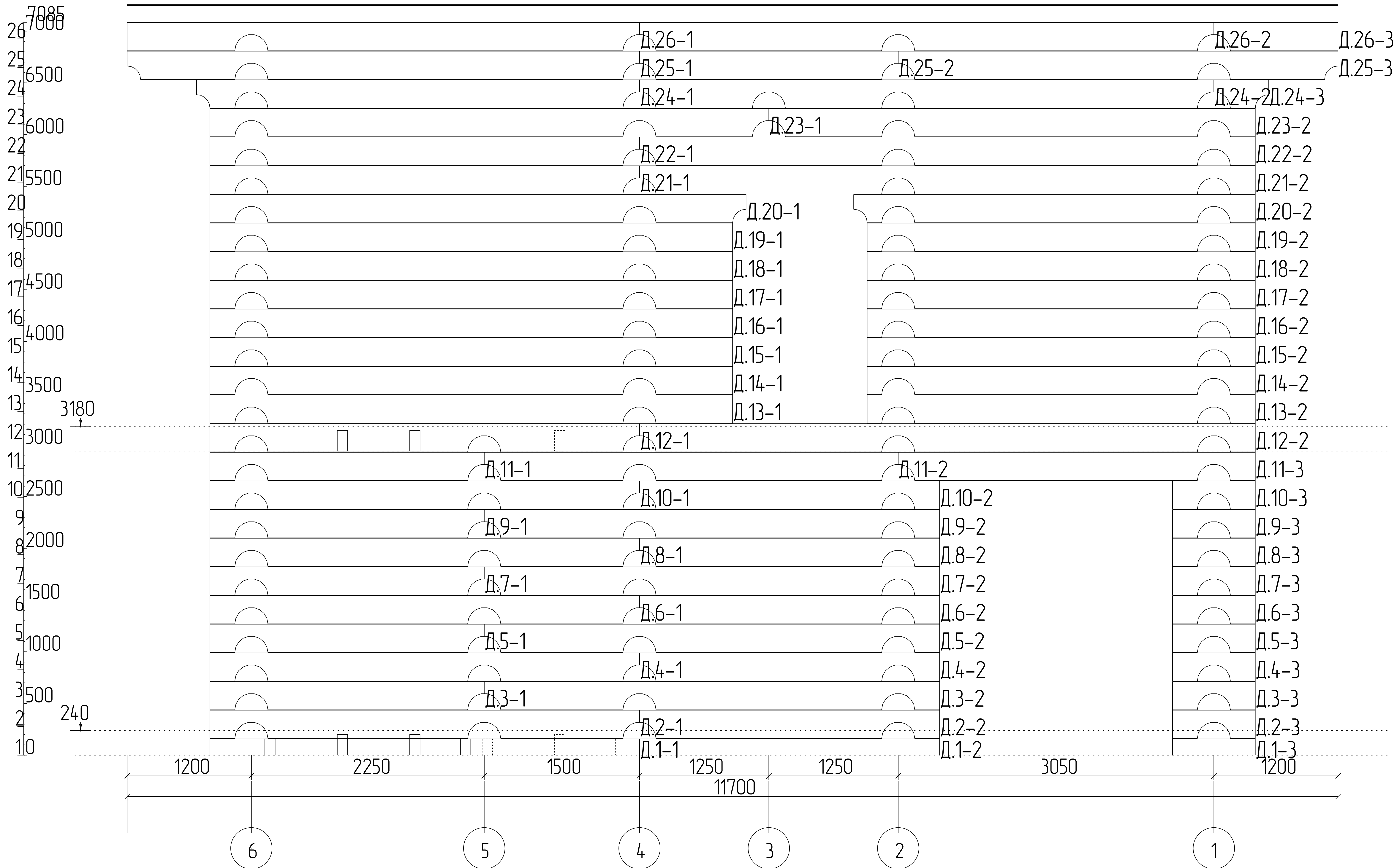
				Спецификация: ось Г	Лист 1:100
--	--	--	--	---------------------	---------------

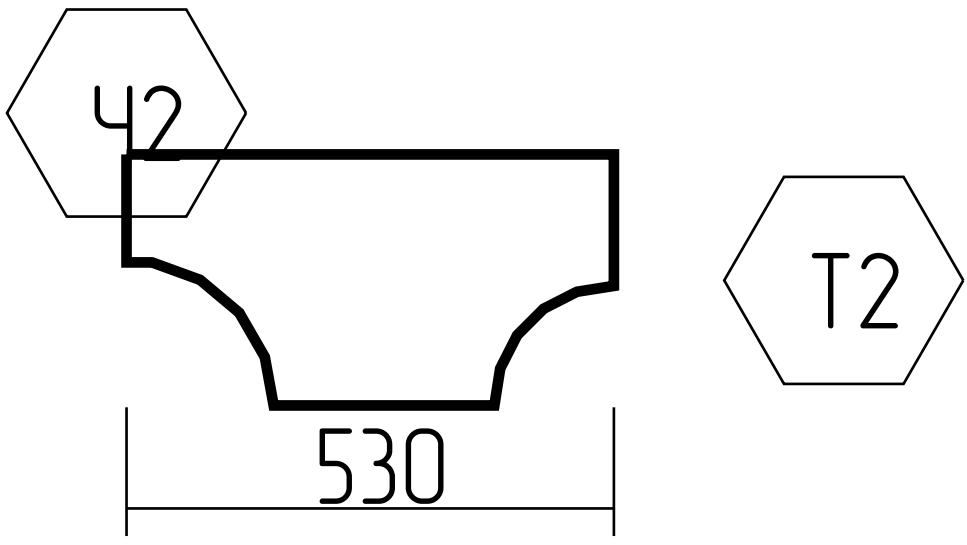
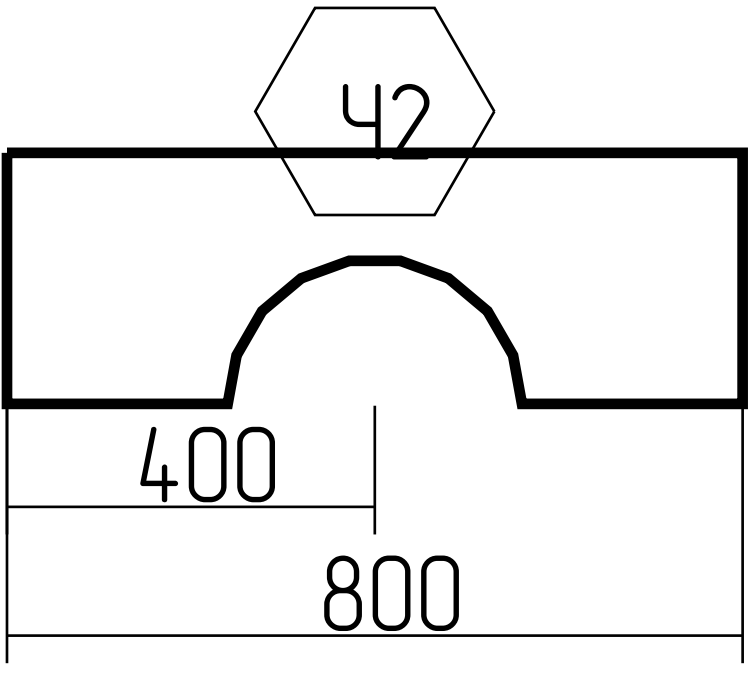
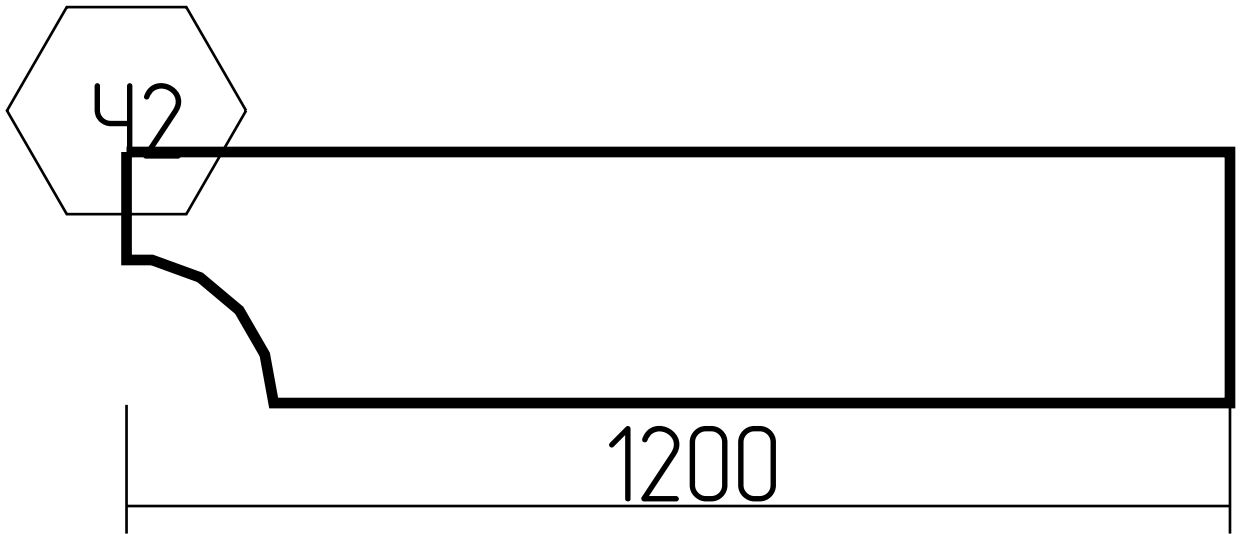
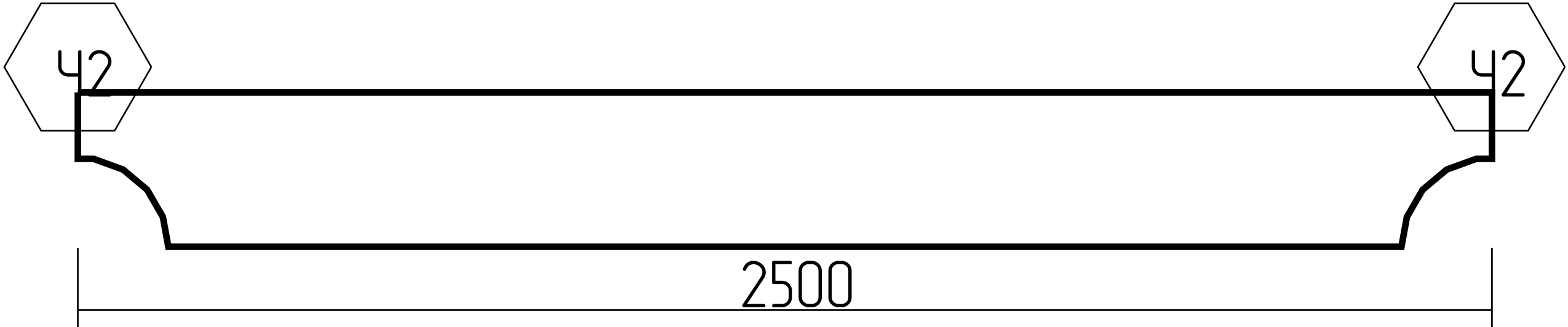
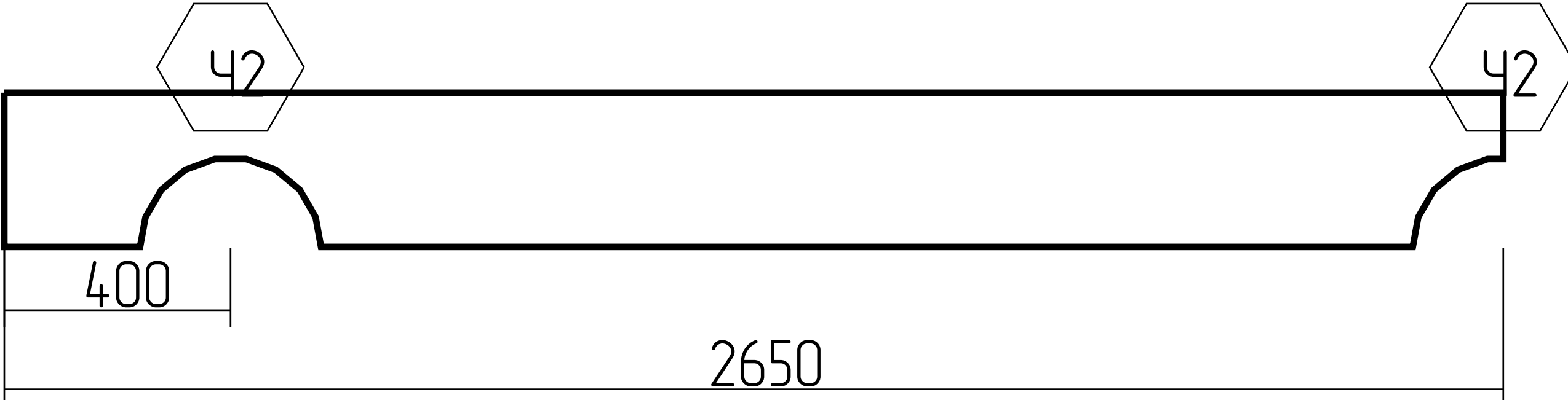

Лист  
 План порядовки: ось Д  
 1:49

№	Марк.	Эскиз детали	Кол-во (шт)	Объем (м.куд.)
1	Д.24-3		1	0.043
2	Д.2-3, Д.3-3, Д.4-3, Д.5-3, Д.6-3, Д.7-3, Д.8-3, Д.9-3, Д.10-3,		9	0.579
3	Д.26-3		1	0.097
4	Д.25-2		1	0.201
5	Д.3-1, Д.5-1, Д.7-1, Д.9-1, Д.11-1		5	1.066

Спецификация: ось Д

Лист

1:100

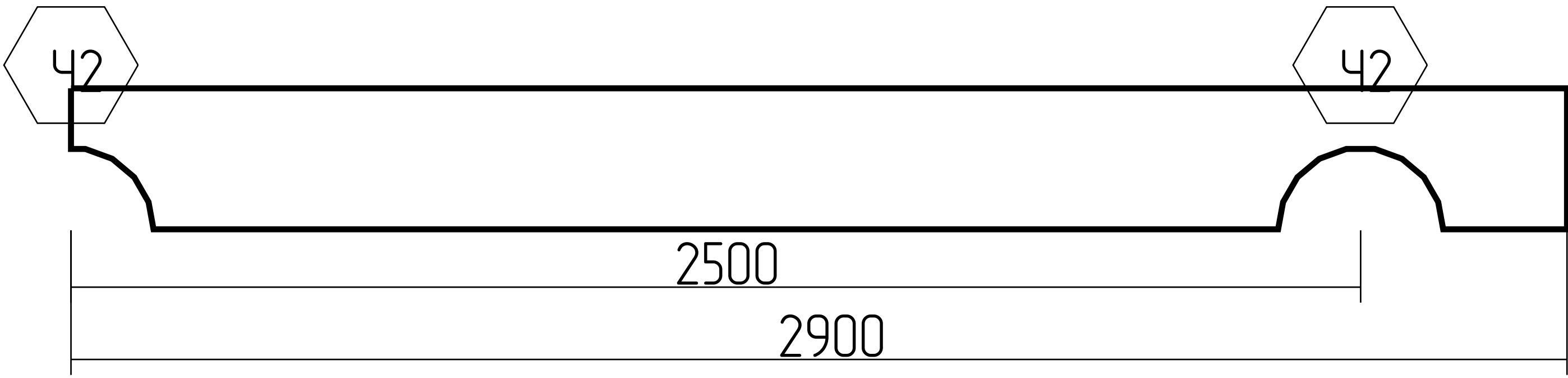
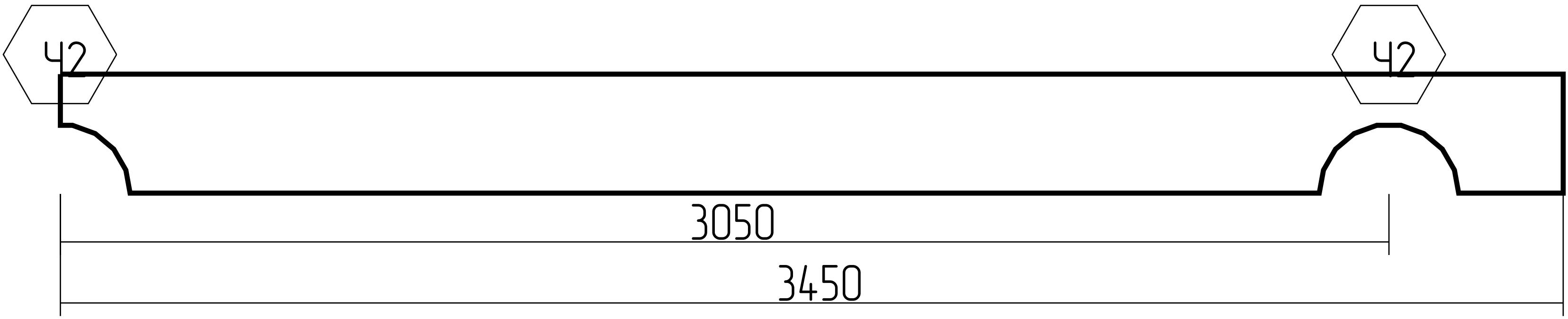
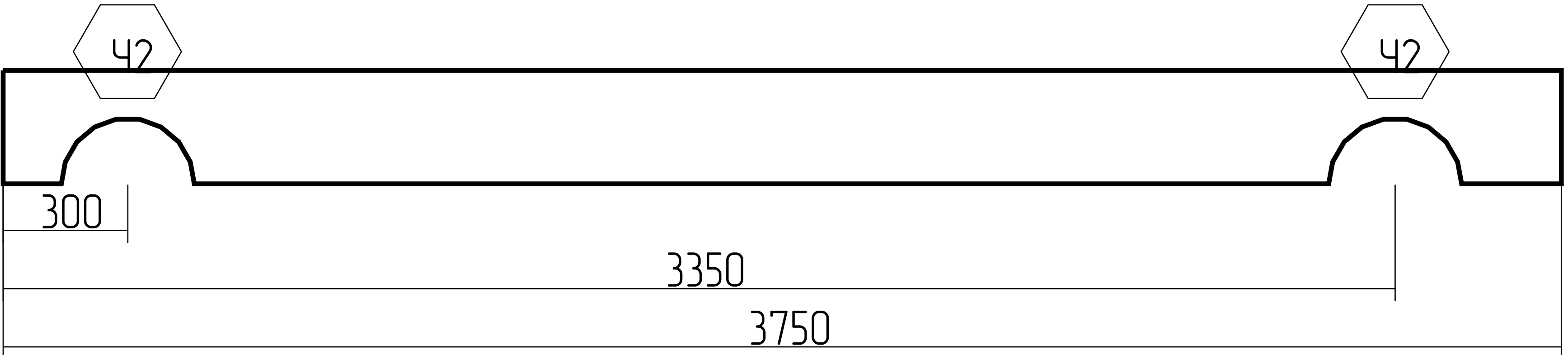
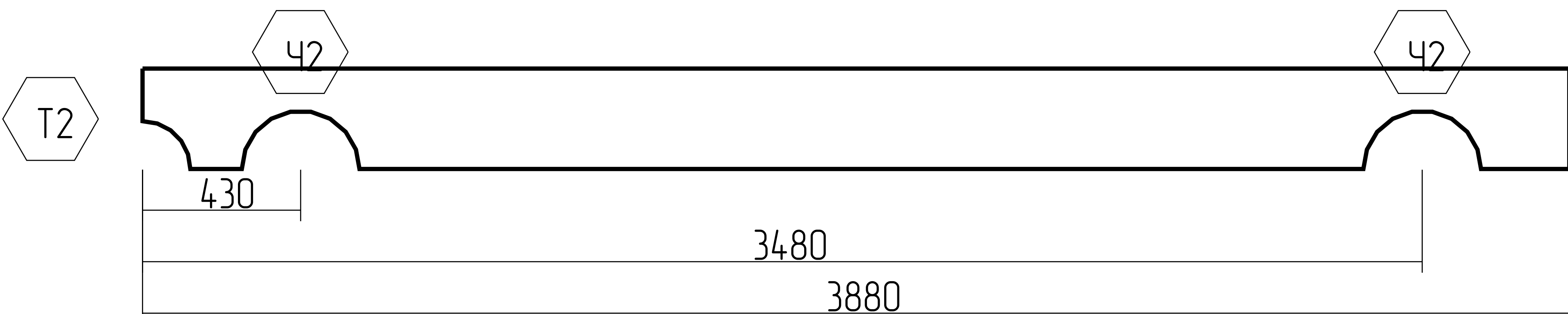
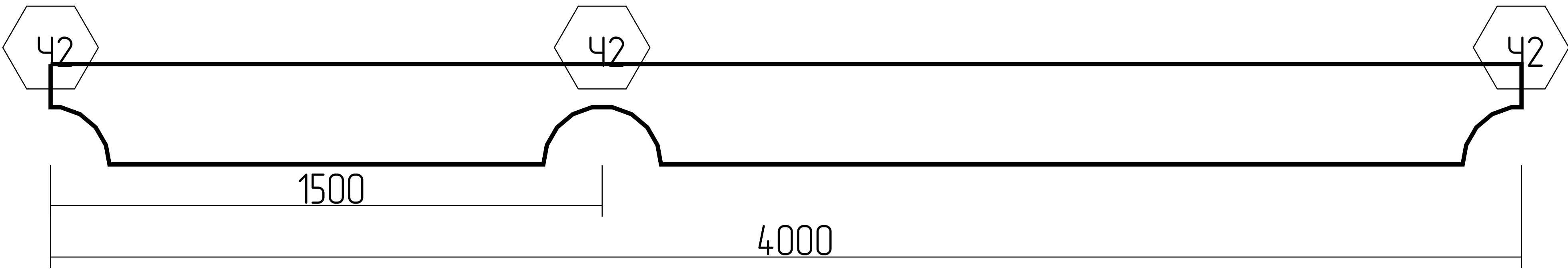
6	Д.2-2, Д.4-2, Д.6-2, Д.8-2, Д.10-2		5	1.166
7	Д.11-3		1	0.277
8	Д.13-2, Д.14-2, Д.15-2, Д.16-2, Д.17-2, Д.18-2, Д.19-2,		7	2.111
9	Д.20-2		1	0.312
10	Д.11-2		1	0.322



Спецификация: ось Д

Лист  
1:100

11	Д.2-1		1	0.334
12	Д.4-1, Д.6-1, Д.8-1, Д.10-1		4	1.335
13	Д.12-1		1	0.334
14	Д.21-1, Д.22-1		2	0.668

Спецификация: ось Д

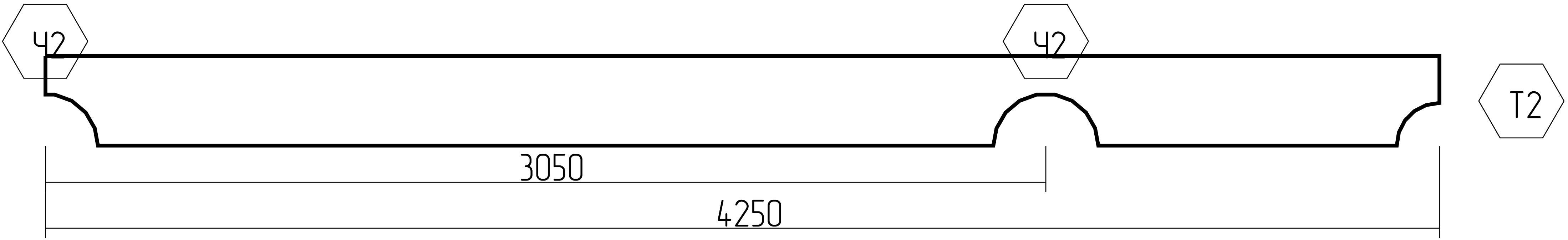
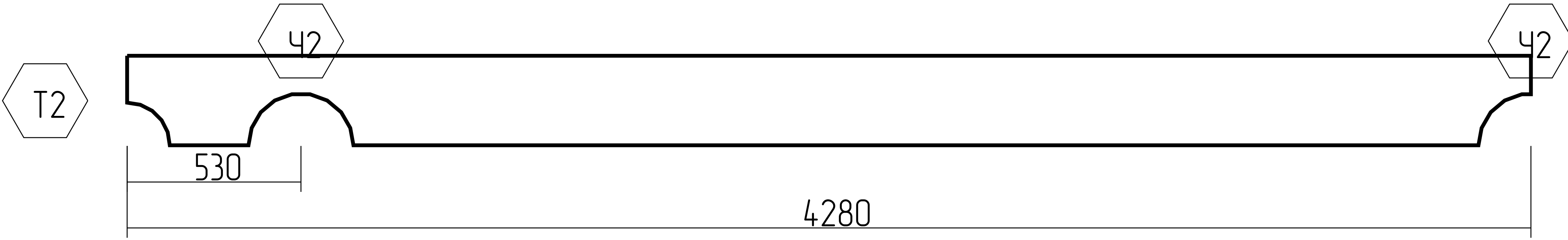
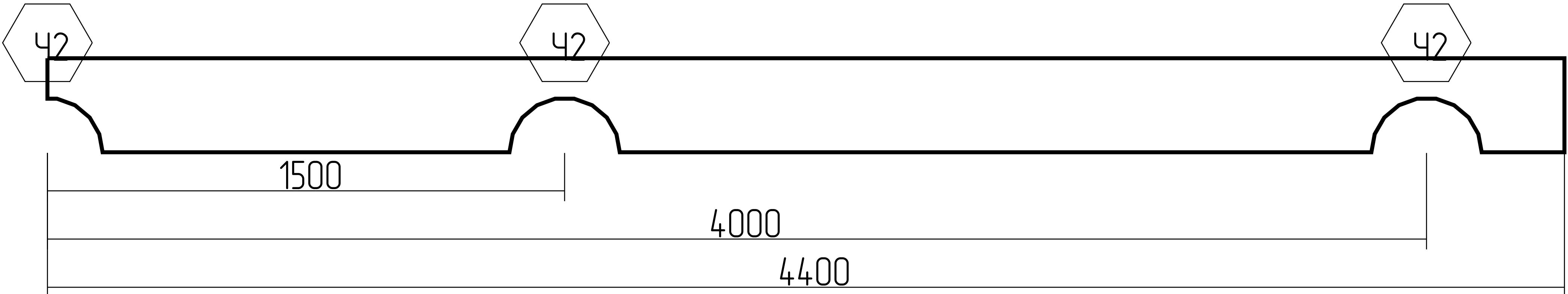
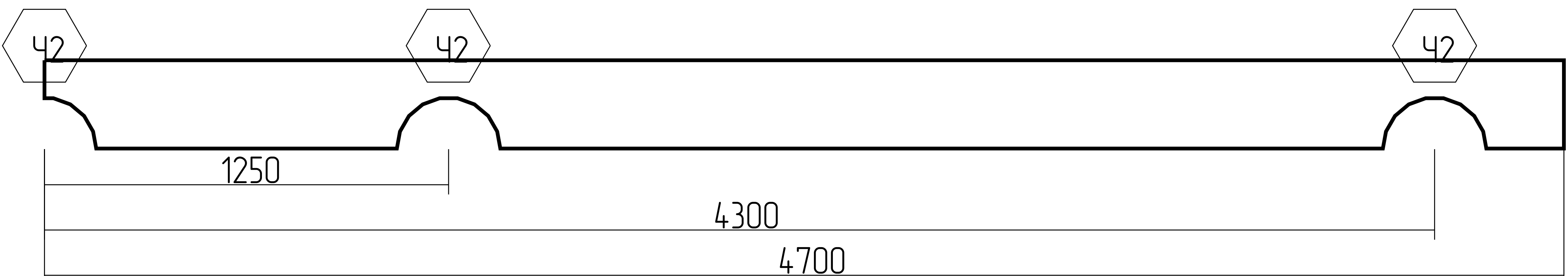
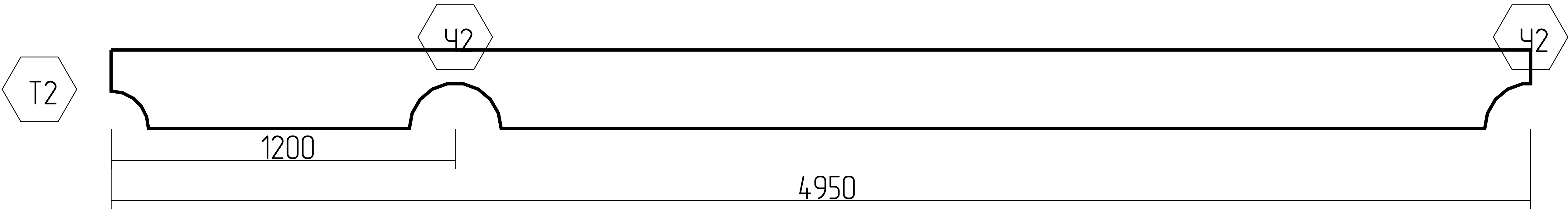
Лист
1:100

15	Д.25-3		1	0.342
16	Д.24-1		1	0.344
17	Д.3-2, Д.5-2, Д.7-2, Д.9-2		4	1.415
18	Д.23-2		1	0.378
19	Д.25-1		1	0.398

Спецификация: ось Д

Лист  
1:100

20	Д.26-1		1	0.398
21	Д.13-1, Д.14-1, Д.15-1, Д.16-1, Д.17-1, Д.18-1, Д.19-1,		7	2.843
22	Д.20-1		1	0.417
23	Д.23-1		1	0.434
24	Д.24-2		1	0.446

Спецификация: ось Д

Лист  
1:100

25	Д.26-2		1	0.446
26	Д.12-2, Д.21-2, Д.22-2		3	1.436
27	Д.1-3		1	0.032
28	Д.1-2		1	0.117
29	Д.1-1		1	0.167
Итого:			66	18.457

Спецификация: ось Д

Лист

1:100



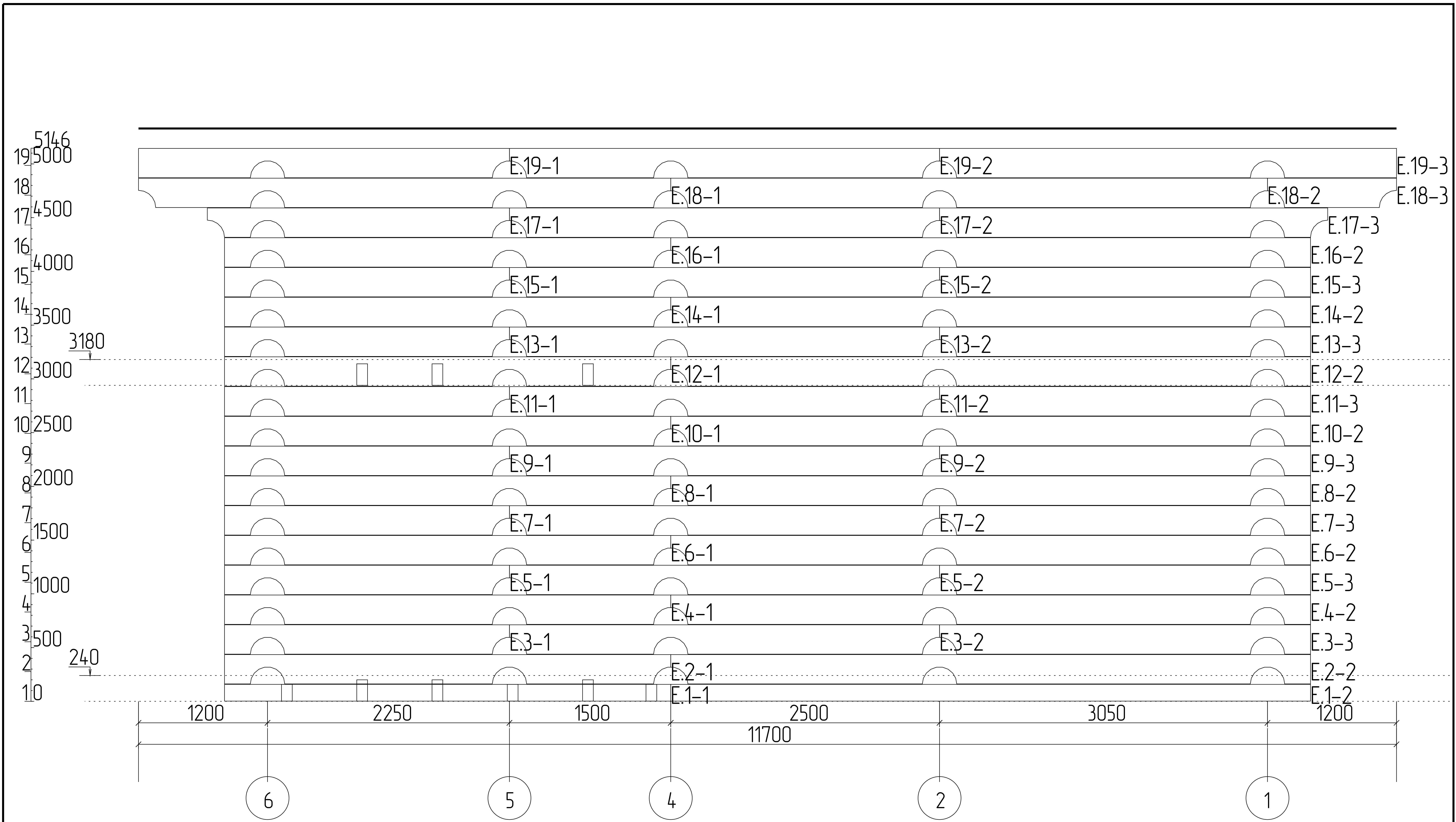

					План порядовки: ось Е		Лист
							1:47

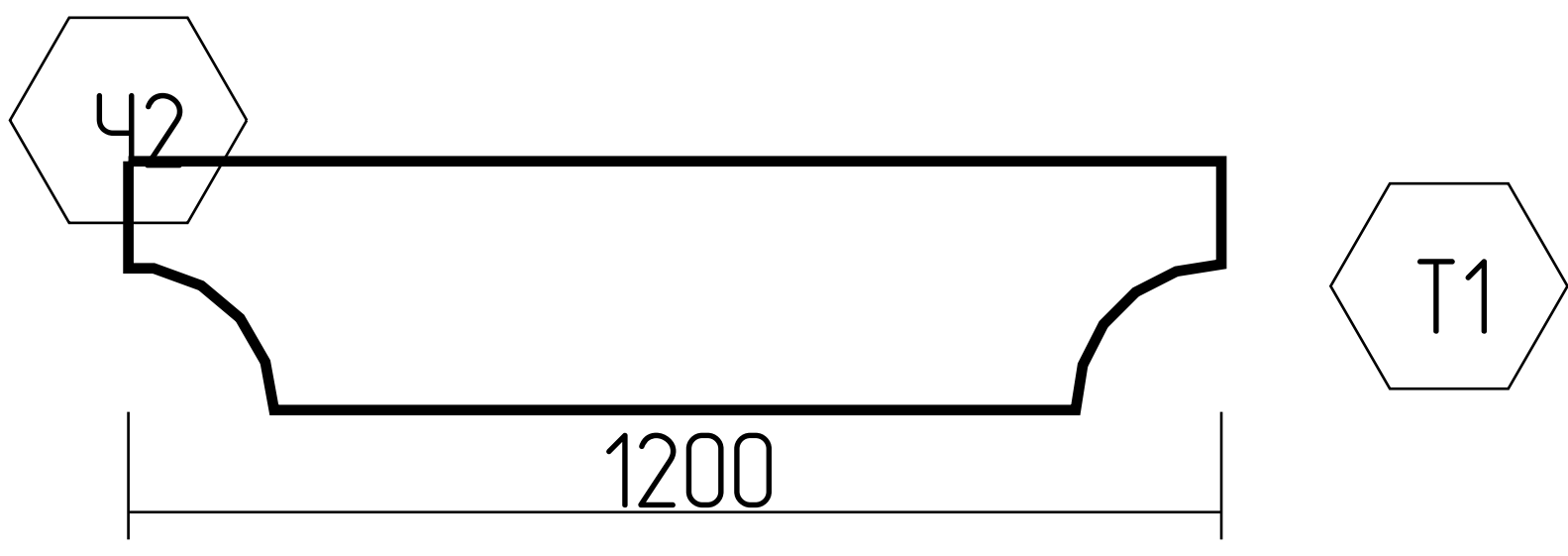
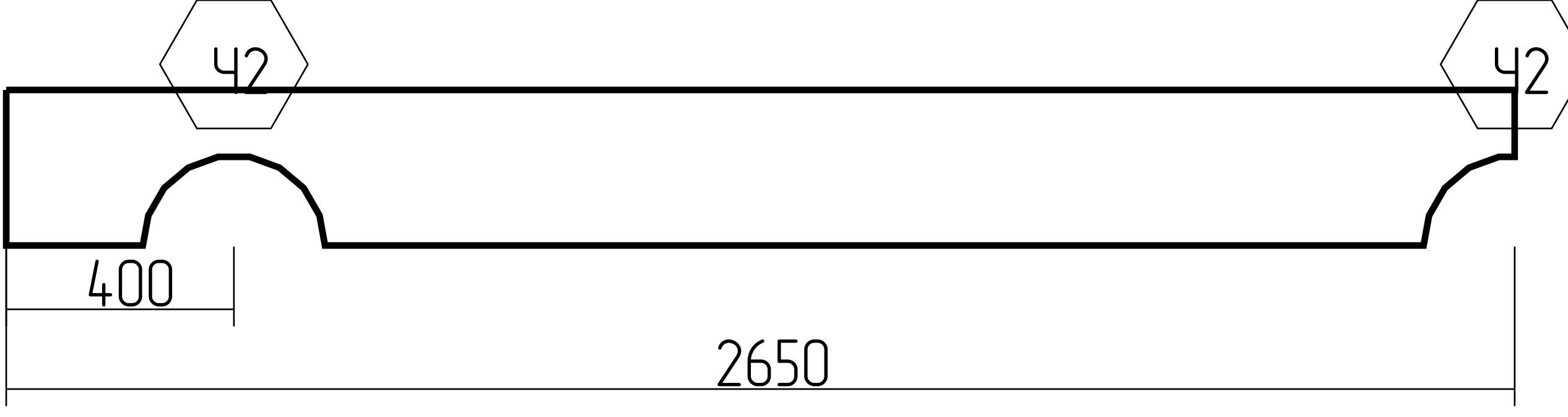
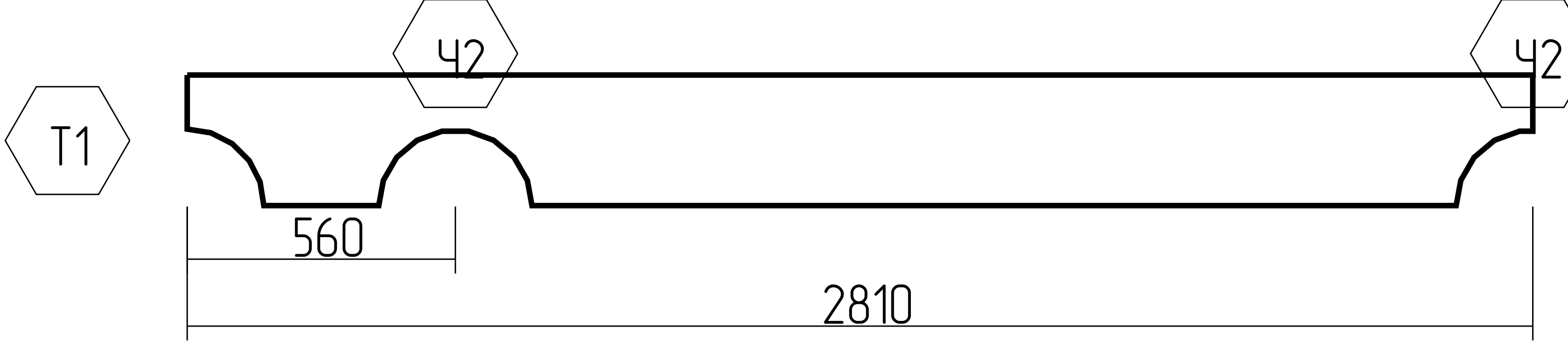
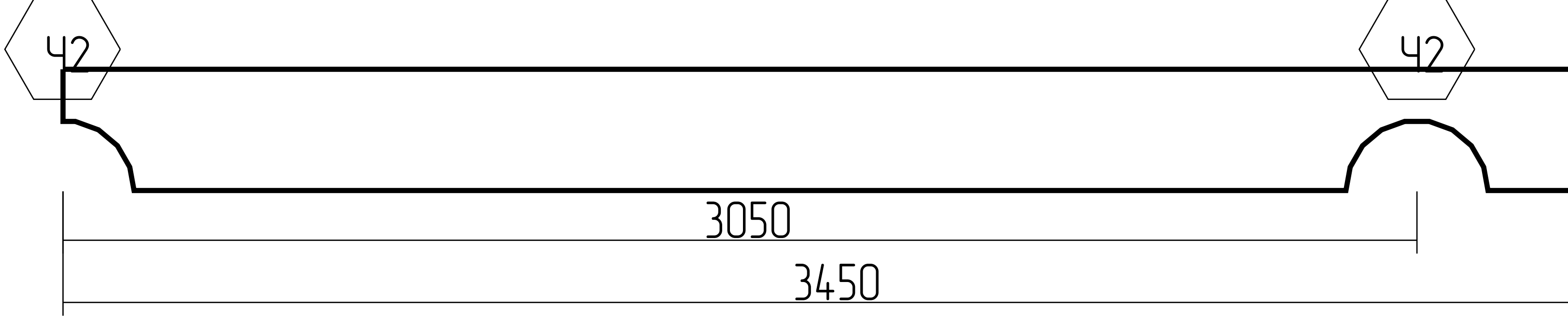
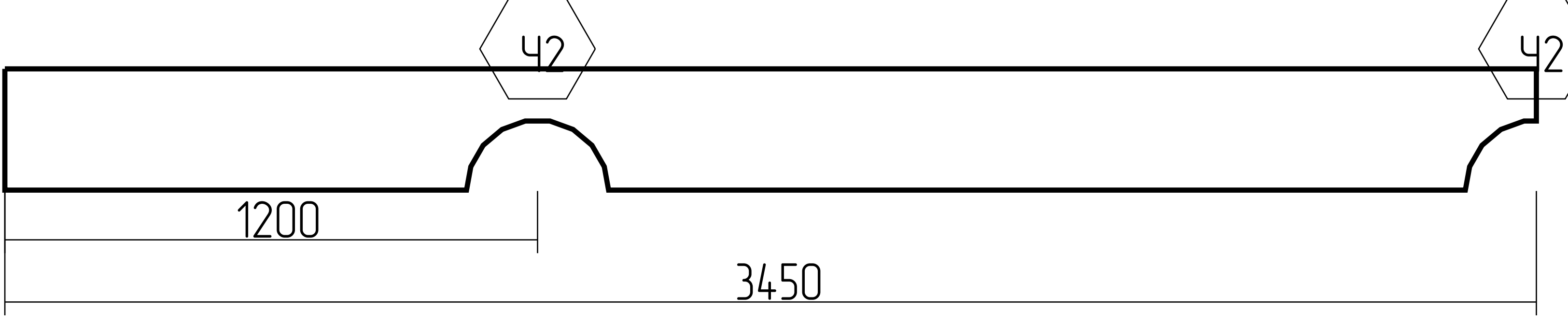
№	Марк.	Эскиз детали	Кол-во (шт)	Объем (м.куб.)
1	E.18-3		1	0.097
2	E.3-1, E.5-1, E.7-1, E.9-1, E.11-1, E.13-1, E.15-1,		7	1.492
3	E.17-1		1	0.226
4	E.3-3, E.5-3, E.7-3, E.9-3, E.11-3, E.13-3, E.15-3,		7	1.942
5	E.19-1		1	0.277

Спецификация: ось E

Лист

1:100

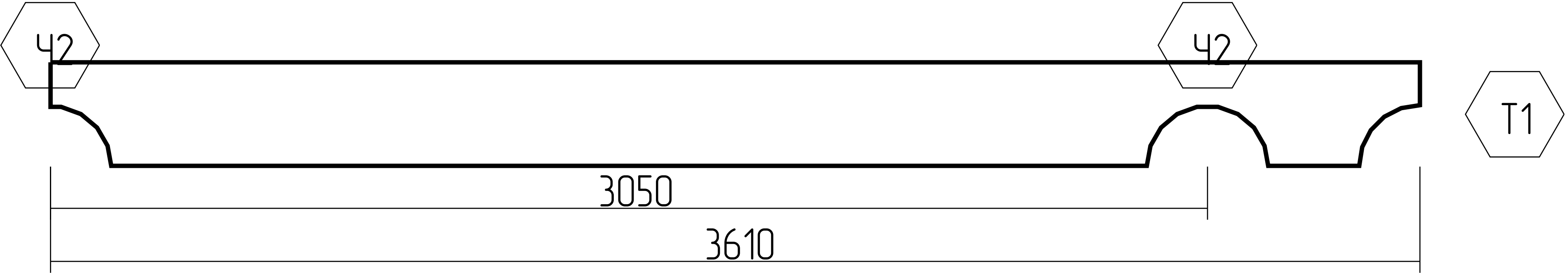
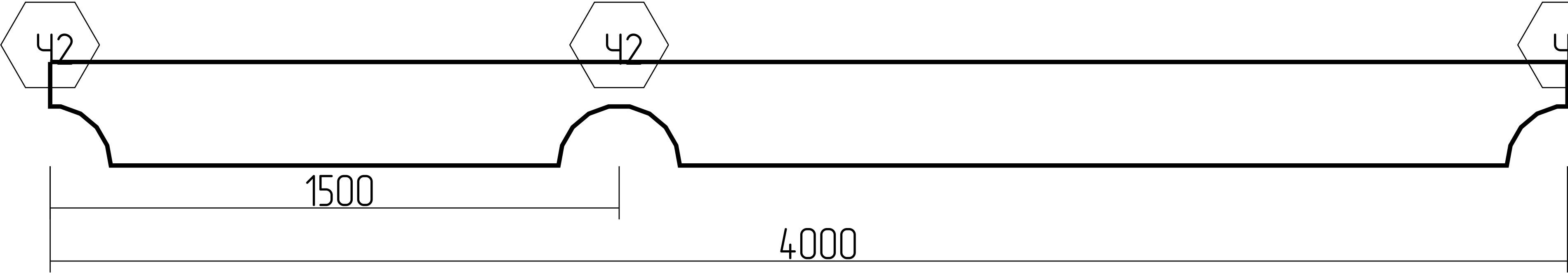
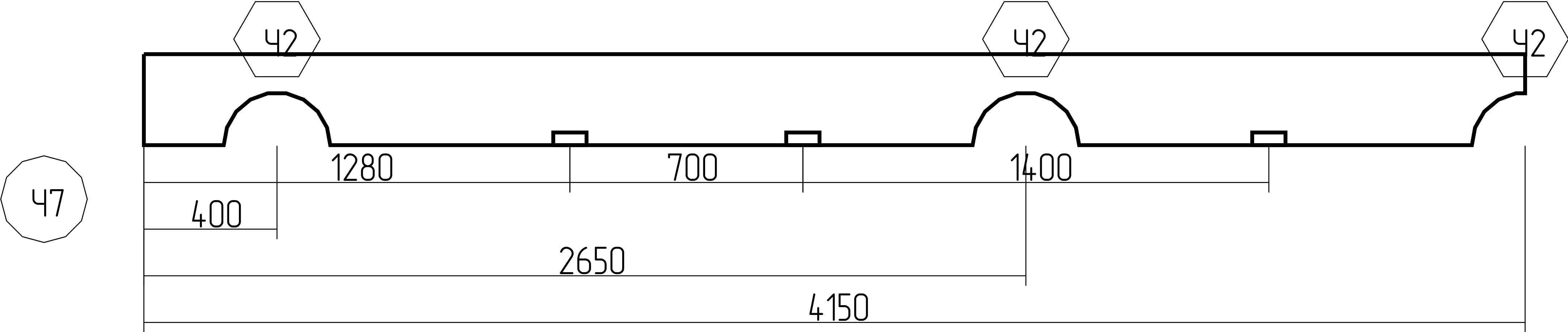
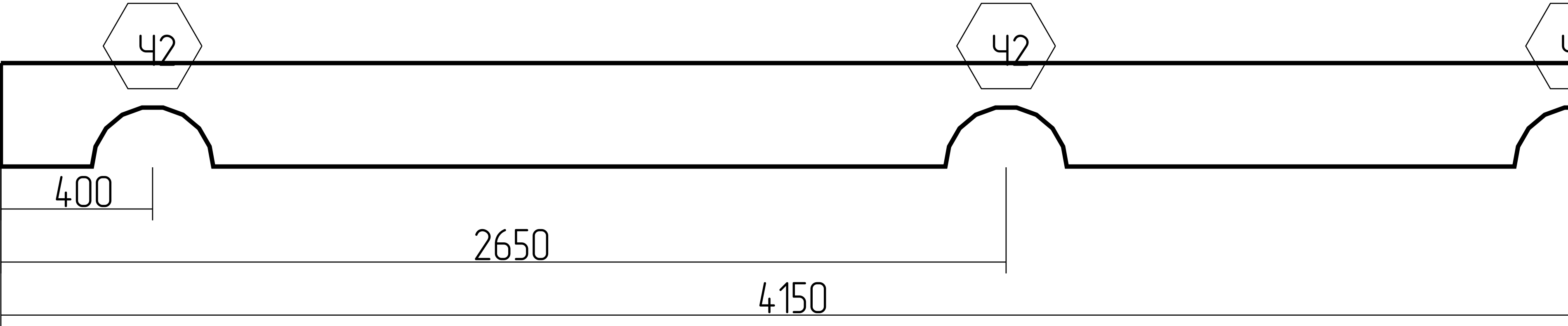
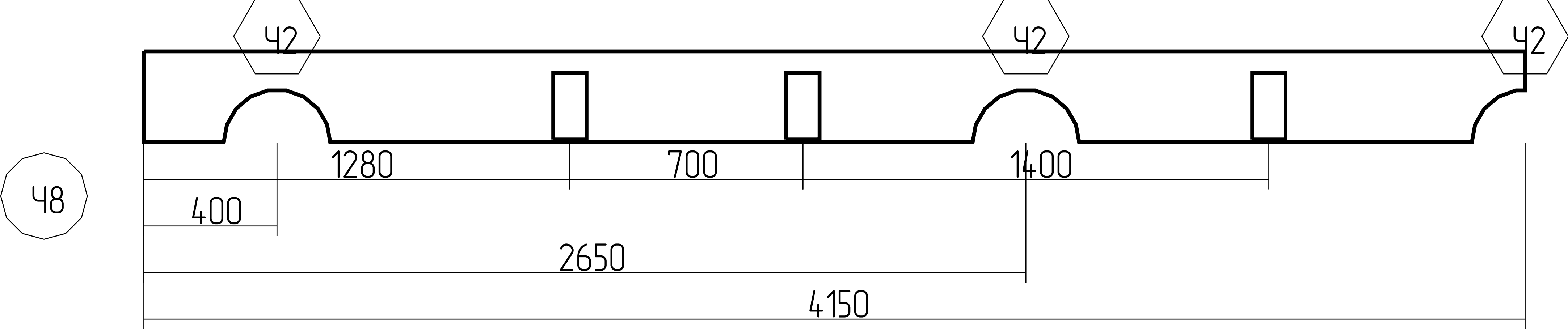
6	E.17-3		1	0.290
7	E.3-2, E.5-2, E.7-2, E.9-2, E.11-2, E.13-2, E.15-2, E.17-2, E.19-2,		9	2.895
8	E.2-1		1	0.334
9	E.4-1, E.6-1, E.8-1, E.10-1, E.14-1, E.16-1		6	2.003
10	E.12-1		1	0.334

Спецификация: ось E

Лист

1:100

11	E.19-3		1	0.342
12	E.18-1		1	0.398
13	E.18-2		1	0.446
14	E.2-2, E.4-2, E.6-2, E.8-2, E.10-2, E.12-2, E.14-2, E.16-2		8	3.828
15	E.1-1		1	0.167
16	E.1-2		1	0.239
Итого:			48	15.310

Спецификация: ось E

Лист

1:100

№	Марк.	Высота (мм)	Ширина (мм)	Длина (мм)	Кол-во (шт)
1	См1	240	240	2500	4

				Спецификация столбов	Лист
					1:100